



Gravel
DEFENSE

GRAVEL DEFENSE DIVISION

DISTRIBUTION CATALOG





TABLE OF CONTENTS

| | |
|-----------------------------|---------|
| GRAVEL DEFENSE STORY | 4-15 |
| A.R.M.S., INC. | 16-19 |
| ADVANCED ARMAMENT CORP. | 20-23 |
| BARNES BULLETS | 24-25 |
| BRAVO COMPANY MANUFACTURING | 26-31 |
| BUSHMASTER FIREARMS | 34-35 |
| CMC TRIGGERS | 36-39 |
| DPMS | 40-51 |
| EOTECH | 52-59 |
| ERGO GRIPS | 60-62 |
| ESTY BREACHING | 64-65 |
| GEISSELE AUTOMATICS | 66-69 |
| HARRIS BIPOD | 70-71 |
| KNIGHT'S ARMEMENT COMPANY | 72-80 |
| LANCER | 82-83 |
| LANTAC | 84-85 |
| LASERMAX | 86-87 |
| MAGPUL | 88-105 |
| MANTIS | 106-107 |
| MEC-GAR | 108-109 |
| MESA TACTICAL | 110-111 |
| MIDWEST INDUSTRIES | 112-115 |
| NOVESKE | 116-117 |
| PHASE 5 | 118-119 |
| RADIAN WEAPONS | 120-121 |
| REMINGTON DEFENSE | 122-139 |
| TIMNEY TRIGGERS | 140-141 |
| V SEVEN WEAPON SYSTEMS | 142-145 |
| WARNE SCOPE MOUNTS | 146-147 |
| WILSON COMBAT | 148-150 |
| XS SIGHT SYSTEMS | 152-154 |

Gravel Defense Division connects industry-leading manufacturers, various government and law enforcement agencies to provide them with the solutions they require and to enhance their capabilities to face the unpredictable nature of their duty.





Gravel

 DEFENSE

For over **20 years** our defense division has established itself as a proud supplier of ammunition, firearms and frontline equipment to the following professionals:

- ★ **Federal / Provincial / Municipal Law Enforcement agencies**
- ★ **Federal / Provincial Wildlife management and protection agencies**
- ★ **Federal / Provincial Energy Departments**
- ★ **National Defense**
- ★ **Border Patrol agencies**

YOU KNOW WHAT IS NEEDED. WE KNOW HOW TO FIND IT.

Gravel is proud to be a turn-key organisation. Throughout the years we developed and diversified our capabilities to suit all your needs. Whatever your needs may be, you will benefit from our team's expertise and our 30 years of experience in distribution and commercialisation. With every passing year, we developed ourselves and our proficiency to adapt with the growing need of modern partners in order to fulfill their every need:

- ★ Representation
- ★ Distribution
- ★ Customer Service
- ★ Production and manufacturing
- ★ Maintenance and repair
- ★ Upgrade programs
- ★ After sales and warranty program
- ★ Communication and media development

Our nation's finest trust us to provide what is needed, when it is needed. What are you waiting for?





AGENCE GRAVEL

5

AFTER SALES >



IF YOU NEED BACKUP, WE'VE GOT YOU COVERED.



› EXPERT GUNSMITHS AT YOUR DISPOSAL

We know that not every agency has easy access to a team of qualified firearm repair technicians. Our staff is fully trained with the latest and greatest equipment, techniques and tooling.

› MAINTENANCE & REPAIR

Our team of dedicated, specialized gunsmiths can answer every need, from a simple inspection to the complete maintenance and repair program for your arsenal.

› UPGRADE PROGRAMS

Gravel defense is a gateway to the world's best products to keep your aging – but still operating – arsenal running. Our unique capabilities and update programs will help you extend the service life to operator the tools that they your operators are familiar with.

› AFTER SALES AND WARRANTY

As part of our commitment to those professionals who put their life on the line, is to we stand 100% behind our service and product. We have your back, whatever the situation. Our extensive experience as the Canadian representative of renowned manufacturers gives us the necessary tools to be able to offer you simple and efficient service when any challenges arise.

EVERYTHING RELATED TO IMPORT/EXPORT LICENSES

DELIVERIES ACCORDING TO YOUR REALITY

Regardless of your area of specialization, our logistics team will adapt to your needs. We will orchestrate everything to meet your requirements! We are experienced in delivering various categories of merchandise, including:

- ★ Dangerous goods
- ★ Oversized shipments
- ★ Heavy loads

BROKERAGE, IMPORT / EXPORT LICENSES

Throughout the years we have mastered the process of importing and exporting merchandise. Our team stays up to date on all of the new rules and regulations. By allowing us to help you with licensing and other administrative-related tasks, you'll be able to:

- ★ Showcase your brand and reap new profits
- ★ Eliminate waiting time
- ★ Let your brand shine from coast to coast
- ★ Avoid mistakes and unpleasant surprises





With our modern, state-of-the-art logistics service, we have developed excellent relationships with trusted transporters. By working closely with them, we can deliver merchandise to Canada's furthest regions in record time.

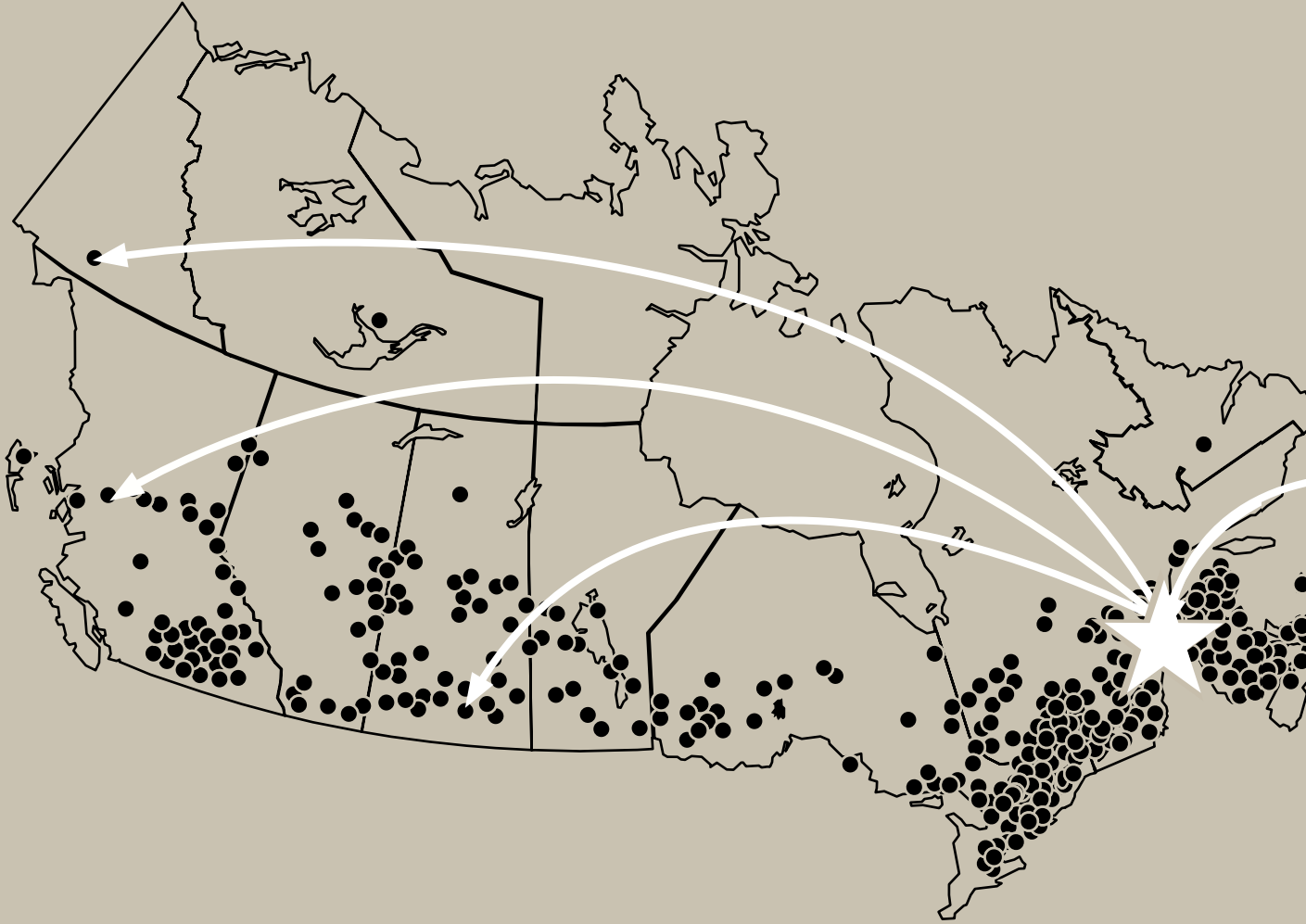

DISTRIBUTION SERVICES

Coast to Coast coverage

Let us handle the import/export licenses, warehousing and logistics. We'll take care of everything to ensure that your products are in stores! Your brand will surge in the Canadian market and on the web. By selecting the right transportation companies, we ensure deliveries are shipped quickly and cost efficiently.



OVER 900 DEALERS AND GOVERNMENT AGENCIES ACROSS CANADA.



**MORE THAN 40
PROMINENT BRANDS**



OVER 40 EMPLOYEES



**MORE THAN 12,000
ORDERS AND 380,000 ITEMS
SHIPPED ANNUALLY**



CIVIL ARMS >



**WE GO THE EXTRA MILE TO
BRING YOU THE BEST THE
INDUSTRY HAS TO OFFER**



CIVIL ★ ARMS

Civil Arms is our sister company based in Skowhegan, Maine, USA. We proudly supply firearms and accessories to international commercial dealers and distributors. Our experienced team of compliance experts always provides the best service, ensuring that all transactions are in accordance with the most recent regulations.

Consultation & training

The licensing of exports and imports to and from the United States has become extremely complex. Civil Arms specializes in assisting companies negotiate the stressful waters of exporting and importing. We can help you with everything to do on licensing and exemptions, with our:

- ★ Specialized staff in international distribution and exportation out of the United States
- ★ 350+ active dealers and distributors worldwide
- ★ ITAR licensing via D-Trade
- ★ Commerce Department SNAP-R licensing
- ★ BATFE, ITAR/EAR training seminars
- ★ Customized training, compliance manuals, and much more

Our focus is to help companies efficiently import and export while complying to U.S. regulations.

A.R.M.S., Inc.



RINGS & MOUNTING SYSTEMS



ACOG THROW LEVER

The #19-33 mounts your Trijicon ACOG TA-33 with A.R.M.S. throw lever.

19-33



RINGS

Rings now available for 34 mm scopes • Spacers also available to give you 1/2" additional height to the rings.

22-34



THROW LEVER RINGS (HIGH)

30 mm ring, secured with dovetail system to an extruded aluminum platform • Height: 1.450"

22H



THROW LEVER RINGS (LOW)

All steel 30 mm ring, secured with dovetail system to an extruded aluminum platform • Height: 0.925"

22L



THROW LEVER RINGS (MEDIUM)

All steel 30 mm ring, secured with dovetail system to an extruded aluminum platform • Height: 1.150"

22M



THROW LEVER RINGS

Designed exclusively for the Aimpoint Comp. ML 1, ML 2 and ML 3 sights.

22M68



EXTENSION

Cantilever spacer that increases the height of the M68 or TX30 mount by 1/2" and moves the optic 1 3/4" farther forward than the standard spacer.

22M68EXT



HALF SPACER

Half spacer for #22M68T and #22TX30T mounts • Height: 1/4"

22M68HALFSP



TACTICAL RING SIGHT

The #22 tactical ring sight provides a back up iron sight in the form of a V-notch on top of the tactical ring.

22TRS



SPACERS FOR 22-34 MM RINGS

1/2" spacers for #22-34T rings • These only work with the #22-34T rings.

22-34SP



AIMPOINT T-1

Aimpoint T-1 micro mount & spacer set • Includes #31 throw lever mount for the Aimpoint T-1 Micro sight & A.R.M.S. #31 spacer.

31/31SPSET



SPACER FOR AIMPOINT MICRO MOUNT

Spacer for the #31T micro throw lever mount.

31SP

RINGS & MOUNTING SYSTEMS



MEDIUM RINGS

30 mm track mounting rings that attach to rail foundations that have stainless steel helicoil threaded holes imbedded into the center channel of the rail between the Mil-Spec dovetail rails, allowing perfect solid alignment • Height: 1.25"

35M



QUICK DETACH THROW LEVER MOUNT

#35TQD attaches with throw levers to fit all Mil-Spec 1913 dovetail rails • This magnificent system will allow the soldier or sportsman to accommodate virtually any 30 mm optic

35QD



ULTRA LOW RINGS

Ultra Low rings that attach to rail foundations that have stainless steel helicoil threaded holes imbedded into the center channel of the rail between the Mil-Spec dovetail rails, allowing perfect solid alignment • 30 mm ring

35UL



TRIJICON REFLEX SIGHT

Trijicon reflex sight throw lever mount spacer • Weight: 0.6 oz • Height: 0.135 in

155P



TRIJICON TRI-POWER

Short carry handle mount for Trijicon Tri-power optic • Fits in the carry handle of the M16A1 and M16A2, and has iron sight see thru.

16T



DUAL THROW LEVER

Dual throw lever mount attaches to the Surefire M900-series weaponlight.

17DL



THROW LEVER MOUNT

Short single throw lever Mt. • Same mounting platform as the #17 • Measures 1 9/16"

17S



ACOG CHANNEL THROW LEVER

The #19 ACOG throw lever mount for ACOG scopes features most of the design of the #19, with the addition of the ACOG channel.

19ACOG



ACOG CHANNEL THROW LEVER

The #19S ACOG is a compact single throw lever base that is the same length as the built in M16 carry handle mounting platform (approx. 4") found on all ACOG scopes.

19SACOG



TANGENT INTEGRATED TILT SIGHT MT.

Standard mount and universal rail adapter • A.R.M.S. throw lever system

78U



TANGENT INTEGRATED TILT SIGHT MT.

#78UR-R tangent integrated Tilt sight mount with universal rail adapter and #21T 30 mm stanag rings • throw lever system

78UR-R



TANGENT INTEGRATED TILT SIGHT MT.

#78T STD mount and universal rail adapter with #22LT 30 mm throw lever ring.

78UR-TL

RAILS & BASES



TACTICAL RING RAIL

The #22 tactical ring rail allows mounting of devices to the top of your scope ring
22TRR



EX OSR SWAN SLEEVE

Optical sight rail 5.56 caliber • This OSR slides over the receiver from the rear of the weapon and extends 8.46"
36EXT(5.56)



M16A1A2 SCOPE MOUNT

Mount for the AR-10 rifle's carry handle will also work with AR15/M16 • Weight: 3 oz • Length: • Approx. 6.5"
2EXT



M16A1A2 SCOPE MOUNT

Mount for the AR-10 Rifle's carry handle will also work with AR15/M16 • Weight: 3 oz • Approx. 6.5"
38SEXT(MODGENII)



TOP RAIL

Top rail for the #50T Bi-level S.I.R. system to make the rail all one height.
50002



EX AR-10 OSR SWAN SLEEVE

Optical sight rail 7.62 caliber • Length 9 3/4"
36EXT(AR-10)

HANDGUARD ACCESSORIES



S.I.R. SYSTEM RAIL

Integrated rail for the S.I.R. system • 2 1/2" long
1RAIL



S.I.R. SYSTEM RAIL

Integrated rail for the S.I.R. system • 2 1/2" long
2RAIL



THROW LEVER ADAPTER

Harris-type bipod throw lever mount
32BIPODADAPTER

SIGHTS



LOW PROFILE REAR SIGHT

Rear flip up sight with same plane aperture system • For the competition shooter • Low profile flip-up rear sight • .75 MOA
40L



STAND ALONE FLIP-UP

The A.R.M.S. stand alone flip-up sight utilizes the same well proven concept as the rear sight on the swan sleeve system.
40



SILHOUETTE

Folding front sight with integral gas block • Fits standard size AR15 (750) barrel.
41-B



MUZZLE DEVICES



BLACKOUT 51T MUZZLE BRAKE

51T ratchet mount • Highly-efficient muzzle brake design and compatible with AAC sound suppressors • Available: 5.56 mm / 7.62 mm • 1/2-28 / 5/8-24 thread

64132



BLACKOUT 90T MUZZLE BRAKE

AAC 90T muzzle brakes • Highly-efficient muzzle brake design and compatible with AAC sound suppressors • Available: 5.56 mm / 7.62 mm • 1/2-28 / 5/8-24 thread

64133



BLACKOUT 18T MUZZLE BRAKE

The Blackout 18T muzzle brake • Highly-efficient muzzle brake design and compatible with AAC sound suppressors • Available: 5.56 mm / 7.62 mm • 1/2-28 / 5/8-24 thread

64136



BLACKOUT SR7 90T MUZZLE BRAKE

Highly-efficient muzzle brake design and compatible with AAC sound suppressors • Available: 5.56 mm / 7.62 mm

64243



BLACKOUT 18T FLASH HIDER

The Blackout flash suppressor is the most efficient design available • Available: 5.56 mm / 7.62 mm

64137



BLACKOUT 90T FLASH HIDER

The Blackout flash suppressor is the most efficient design available • Available: 5.56 mm / 7.62 mm

64242



SIG MOSQUITO ADAPTOR

This adapter allows you to attach any silencer with 1/2-28 TPI to the sig mosquito pistol with factory threaded barrel.

64150



BLACKOUT FLASH HIDER NON-SILENCER MOUNT

Own the world's most effective flash hider • Caliber: 5.56 mm • 7.62 / 1/2-28 / 5/8-26 thread

64177



BRAKEOUT 2.0 90T COMPENSATOR

The Blackout 2.0 is a silencer mounting muzzle device • 5.56 mm / 7.62 caliber • 1/2-28 / 5/8-24 thread

64206



22 PISTOL ADAPTORS

Allows you to attach any silencer with 1/2-28 TPI to the Walther P22 pistol with factory threaded barrel

64151



BLASTOUT RATCHET MOUNT

BlastOut 51T for use with all 51T devices. BlastOut 90T for use with all 90T taper SR series mounts.

64280



THREAD PROTECTOR

For use on any barrel threaded steel construction • Available in all standard thread configuration

64207



BLACKOUT FLASH HIDER INSTALLATION/REMOVAL TOOL



The blackout flash hider installation/removal tool enables armorers to quickly and easily install and remove a three-prong blackout flash hider using a 3/8-inch socket wrench.

64185

APPLICATION CHART

| AAC RIMFIRE SILENCER MODELS | | CALIBERS | WEIGHT | LENGTH | DIAMETER |
|-----------------------------|---|--|-------------------------------|----------------------------|----------|
| HALCYON |  | 17 HMR, 22 LR 22 Win Mag 5.7x28 mm | 6.1 oz Full 4.5 oz Compact | 5.8" Full 3.41" Compact | 1.0" |
| ELEMENT2 |  | 22 LR 22 Win Mag 17 HMR 17 Mach 2 | 4.7 ounces | 5.2" (4.7" added) | 1.0" |
| AVIATOR2 |  | 22 LR | 4.0 ounces | 6.4" (6.0" added) | 1.0" |

| AAC PISTOL SILENCER MODELS | | CALIBERS | WEIGHT | LENGTH | DIAMETER |
|----------------------------|---|--|----------------------------|--------------------------------------|----------|
| Ti-RANT 9M |  | 9mm Luger 22 LR | 9.3 ounces 7.7 ounces | 8" (7.6" added) 5.8" (5.4" added) | 1.4" |
| Ti-RANT 45M |  | 22 LR, 38/357 9mm Luger 300 BLK Subsonic 40 Auto 44 Rem Mag 45 Auto | 12.3 ounces 10.6 ounces | 9" (8.6" added) 6.9" (6.5" added) | 1.4" |
| ILLUSION 9 |  | 9mm Luger 22 LR | 9.6 ounces | 7.9" (7.5" added) | 1.25" |

| AAC RIFLE SILENCER MODELS | | CALIBERS | WEIGHT | LENGTH | DIAMETER |
|---------------------------|---|--|-------------|----------------------|----------|
| M4-2000 |  | 5.56 mm NATO | 18.2 ounces | 6.7" (5" added) | 1.5" |
| MINI-4 |  | 5.56 mm NATO | 13.5 ounces | 5.3" (3.5" added) | 1.5" |
| 556-SD |  | 5.56mm NATO | 18 ounces | 6.7" (5" added) | 1.5" |
| SR-5 |  | 5.56 mm NATO | 17.5 ounces | 6.6" (5" added) | 1.5" |
| Ti - RAID 30 |  | 30 Caliber up to 300 Win Mag. Full Auto: 7.62 NATO and below | 20.1 ounces | 8.1" (8.5" added) | 1.75" |
| SR- 7 |  | 7.62 X 51mm, 300 AAC BLK, 6.8 SPC, 5.56 X 45mm | 19.6 ounces | 7.5" (5.9" added) | 1.5" |

ACCESSORIES



PISTOL BARREL

AAC is proud to offer a line of silencer ready Glock barrels for popular pistols chambered in 9 mm and .45 Auto.

64220



SQUAREDROP HANDGUARD W/ WRENCH

Offered in 8", 11.2" and 13.5" lengths, the unique SquareDrop handguard features extended alignment flanges to ensure a repeatable fit eliminating torque or rotational force movement.

64272



SQUAREDROP ACCESSORY RAIL 3"

AAC's 3-inch Picatinny Accessory Rail is made of Type 3 hard coat anodized.

64267



ELEMENT BAFFLE REMOVAL TOOL

The baffle removal tool can be used to disassemble any .22 rimfire silencer that has a removable front end cap and 1/2-28 TPI threads.

64002



SHIM KITS

Shim kit includes 6 different shims of varying thicknesses for the purpose of properly timing a flash hider or muzzle brake.

64152



300 BLK AR BARREL W/GAS SYSTEM

The 4150 steel barrel features a black nitride finish (including bore and chamber) 1:7" twist for super or sub-sonic use • Barrel length: 9" Ready for silencer use 5/8-24 thread.

64165



AAC 300 | TAC-TX

RIFLE DUTY, BARNES BULLETS, LLC

All-copper TAC-TXT rifle bullets have a proven reputation for accuracy. They're designed for controlled, double-diameter expansion and full functionality at close or long range. These bullets track straighter through barriers and have better weight retention than lead-core bullets.



| GAUGE | CENTERFIRE CARTRIDGES | BULLET WEIGHT (GRS.) |
|------------------|-----------------------|----------------------|
| 300 AAC Blackout | TAC-TX | 110 |



PRECISION MATCH

LEGENDARY BARNES PRECISION, MADE YOURS.

For shooters who demand uncompromising performance and exceptionally accurate, long-range results. Precision Match ammunition is engineered for precision at extreme distances. Barnes' exacting manufacturing and quality standards result in low standard deviations and extreme variations.



| CARTRIDGE | BULLET STYLE | BULLET WEIGHT (GRS.) |
|------------------|---------------------|----------------------|
| 5.56 x 45 mm | Match Burner OTM BT | 69 |
| 300 AAC Blackout | Match Burner OTM BT | 125 |
| 308 Win. | Match Burner OTM BT | 175 |
| 338 Lapua Mag | Match Burner OTM BT | 300 |

★ BCM[®]





BCM RECCE-9 KMR-A PISTOL
503-890

| CALIBER | OPERATION | BARREL LENGTH | OVERALL LENGTH | TWIST | WEIGHT |
|------------------|-----------------------|---------------|----------------|-------|---------|
| 300 AAC Blackout | Direct gas impingment | 9" | 25" | 1-7" | 4.9 lbs |



BCM RECCE-2 KMR-A 300 BLACKOUT
523-890

| CALIBER | OPERATION | BARREL LENGTH | OVERALL LENGTH | TWIST | WEIGHT |
|-------------------|-----------------------|---------------|----------------|-------|---------|
| 5.56 x 45 mm NATO | Direct gas impingment | 12.5" | 28.5" | 1-7" | 5.2 lbs |



BCM RECCE-14 MCMR CARBINE
780-750

| CALIBER | OPERATION | BARREL LENGTH | OVERALL LENGTH | TWIST | WEIGHT |
|-------------------|-----------------------|---------------|----------------|-------|---------|
| 5.56 x 45 mm NATO | Direct gas impingment | 14.5" | 31.5"-34.5" | 1-7" | 6.0 lbs |



BCM RECCE MCMR-LIGHT CARBINE
780-750-LW

| CALIBER | OPERATION | BARREL LENGTH | OVERALL LENGTH | TWIST | WEIGHT |
|-------------------|-----------------------|---------------|----------------|-------|---------|
| 5.56 x 45 mm NATO | Direct gas impingment | 14.5" | 31.5"-34.5" | 1-7" | 5.7 lbs |



BCM RECCE-16 MCMR CARBINE
750-750

| CALIBER | OPERATION | BARREL LENGTH | OVERALL LENGTH | TWIST | WEIGHT |
|-------------------|-----------------------|---------------|----------------|-------|---------|
| 5.56 x 45 mm NATO | Direct gas impingment | 16" | 32.5"-35.5" | 1-7" | 6.1 lbs |



BCM RECCE-16 MCMR PRECISION
RIFLE
752-750

| CALIBER | OPERATION | BARREL LENGTH | OVERALL LENGTH | TWIST | WEIGHT |
|-------------------|-----------------------|---------------|----------------|-------|---------|
| 5.56 x 45 mm NATO | Direct gas impingment | 16" | 32.5"-35.5" | 1-8" | 6.5 lbs |



BCM RECCE-18 KMR-A PRECISION RIFLE
862-790

| CALIBER | OPERATION | BARREL LENGTH | OVERALL LENGTH | TWIST | WEIGHT |
|---------------------------|-----------------------|---------------|----------------|-------|--------|
| 223 Rem / 5.56x45 mm NATO | Direct gas impingment | 18" | 34"-37" | 1-8" | 7 lbs |



BCM MK12 MOD 0 PRECISION RIFLE
862-MK12

| CALIBER | OPERATION | BARREL LENGTH | OVERALL LENGTH | TWIST | WEIGHT | COLOR OPTION |
|-------------------|------------------------|---------------|----------------|-------|---------|--------------|
| 5.56 x 45 mm NATO | Direct gas impingement | 18" | 38" | 1-8" | 8.9 lbs | FDE |



BCM EAG CARBINE
741-EAG-BLK

| CALIBER | OPERATION | BARREL LENGTH | OVERALL LENGTH | TWIST | WEIGHT |
|-------------------|------------------------|---------------|----------------|-------|---------|
| 5.56 x 45 mm NATO | Direct gas impingement | 14.50" | 31.5"-34.5" | 1-7" | 6.3 lbs |

HANDGUARDS



BCM QUAD RAIL FOREND

Featuring the same industry leading barrel nut and lock up design as originally introduced on BCM's evolutionary KMR handguard, the QRF Series of handguards gives the shooter modularity in the picatinny (MIL-STD-1913) platform. Available in 7/8/9/10/12 inch.

BCM-QRF-7-556-BLK



BCM MCMR-9 M-LOK

Featuring the same industry leading barrel nut and lock up design as originally introduced on BCM's evolutionary KMR handguard, the MCMR Series of handguards gives the shooter modularity in the M-LOK platform.

BCM-MCMR-9-556-BLK



BCM KEYMOD RAIL ALPHA

All the advantages and features of Bravo Company's KeyMod rail, now available in 100% aluminum. Handguard flares forward (towards muzzle end) at the 3 and 9 O'clock positions approximately 1/4".

BCM-KMR-A10-556-BLK

UPPER PARTS



BCM BOLT CARRIER GROUP (MPI)

Complete bolt carrier group, fully assembled • ION bonded in Flat dark earth for lowers friction and easier cleaning • Auto version

BCM-BCG-AUTO-MP-FDE-IB



BCM BOLT CARRIER GROUP (MPI)

BCM (MPI) complete bolt carrier group is fully assembled (BCG). Parkerized exterior and chrome lined inside carrier.

BCM-BOLT-CARRIER-GROUP-AUTO-MP



BCM CHARGING HANDLE MOD 3B

The Mod 3B latch extends past the main body of the charging handle by approximately 1.14".

BCM-GFH-556-MOD-A44



BCM CHARGING HANDLE MOD 4B

The Mod 4B latch extends past the main body of the charging handle by approximately .91".

BCM-GFH-MOD3B-556



BCM 16" 300 BLACKOUT

Expect nothing less than professional grade weaponry from BCM. 16" 300 BLK upper receiver group w/ BCM KMR-Alpha 15" Handguard • 1-7 Twist

BCM-URG-300BLK-16-KMR-A15



BCM BFH 14.5" MID LENGTH

BCM These Barreled Upper Receiver Groups are designed for shooting professionals with the Mil-Spec features for the demands of their duty • 1-7 Twist • HPT/MP inspected barrels

BCM-URG-MID-14BFH-ELW-MCMR-13



BCM KEYMOD SLING MOUNT

The BCM KMSM, KeyMod quick detachable sling mount.

BCM-KMSM



BCM LOW PROFILE GAS BLOCK 750

BCM Low Profile Gas Block for AR15, M16, M4, M4A1. Machined of steel, phosphate finish, for .750 barrels.

BCM-LGB-750



BCM A2X FLASH SUPPRESSOR

The A2XT is an extended version of the A2 flash hider found on the M16 and M4 series of rifles. Threaded 1/2"x 28 for your 5.56 mm carbine.

BCM-A2X



BCM KEYMOD ALUMINUM RAIL

Available is three Lengths: 3-inch (5 slot), 4-inch (7 slot) and 5.5-inch (11 slot).

BCM-KMR-1913-A4



BCM RAIL PANEL KIT

Made to fit all mounting surfaces with seven consecutive slots • 5 pack • Available in KeyMod and M-LOK / black and flat dark earth.

BCM-KMR-RP-BLK-5



BCM EXTRACTOR SPRING UPGRADE KIT

The BCM extractor spring is a heavy coil design made for the increased extractor tension required • Improve reliability on standard 16" and 14.5" carbine.

BCM-EXSPRING-3

LOWER PARTS



BCM LOWER RECEIVER GROUP

Receivers Machined from Aluminum Forgings 7075-T6 • Included: BCM PNT Trigger (Polished Nickel Teflon) / BCM QD Sling Mount End Plate / BCM Pistol Grip Mod 3 / BCM Stock Mod 0 / BCM Enhanced Trigger Guard • Available in FDE

LRG-STK-MOD-0-BLK



BCM LRG-PISTOL

Receivers Machined from Aluminum Forgings 7075-T6 • Included: BCM Mod 3 Pistol Grip / BCM QD Sling Mount End Plate / BCM PNT Trigger (Polished Nickel Teflon) / BCM Trigger Guard • Available in FDE

LRG-PISTOL-BK



TRIGGER ASSEMBLY AR-15

The BCM PNT Trigger and PNT Hammer are a precision machined Mil-Spec AISI8620 investment casting per the USGI TDP (Mil-Spec) for M16/M4 family of weapons. 156/157 holes are honed to assist in perfect alignment and a smooth trigger pull.

BCM-PNT-TA1

ACCESSORIES



BCM GUNFIGHTER STOCK MOD 0

BCM Stock Assembly Mod 0 SOPMOD is the strongest light-weight polymer stock available for your mil-spec receiver extension. More pronounced cheekweld.

BCM-GFS-MOD-0-SPMD-BLK



BCM KAG

The KAG is the end result of collaboration between BCM and Travis Haley, founder of Haley Strategic Partners • Available in black and flat dark earth

BCM-KAG-MMR-BLK



BCM GUNFIGHTER VERTICAL GRIP LONG

Mounted in forward angle increase rigidity of the forearms while providing a more natural wrist angle • Available in black / FDE / foliage green

BCM-GFVG-BLACK



BCM GUNFIGHTER GRIP MOD 3

Reduced angle for improved ergonomics and trigger control • Each grip test fit to ensure proper

BCM-GFG-MOD-3-BLK



BCM VERTICAL GRIP MOD 3

Low-profile length for increased mobility and decreased "snag" factor • Manufactured from high quality, impact resistant polymers • Available in black / FDE / foliage green / wolf gray

BCM-VG-1913-MOD-3-BLK



BCM GUNFIGHTER VERTICAL GRIP SHORT

Low-profile length for increased mobility and decreased "snag" factor • Spring-loaded clamps makes installation and removal easier • Available in black / FDE / foliage green / wolf gray

BCM-VG-S-BLK



V-42 DEVIL'S BRIGADE

An important piece of equipment of the Devil's Brigade was the specially designed V-42 combat knife which was also part of the intensive close combat training. The handle of compressed leather discs ends in a pointed impact cap. A thick leather padding underneath the slightly curved pommel had to prevent injuries.

The two-edged blade of the dagger was probably phosphate-coated and features a corrugated thumb rest around the area of the Ricasso. To this day the crest of the Special Forces of the US Army adorns this legendary dagger.





ROCKY ALPHA FORCE ZIPPER WATERPROOF PUBLIC SERVICE BOOT

Public Service boots are comfortable and guaranteed waterproof



Guaranteed Rocky Waterproof
Full-grain water-resistant leather
Rocky Air-Port cushion footbed
Side Zipper for Easy On and Off
Lightweight 1000 denier nylon
8 Inches in height

BUSHMASTER

XM-15 RIFLE SERIES

CRATED WITH STEEL,
ALUMINUM, STRENGTH AND HONOR.



XM15 PATROLMAN A3
90910

| CALIBER | OPERATION | BARREL LENGTH | OVERALL LENGTH | TWIST | WEIGHT |
|---------------------------|------------------------|---------------|----------------|-------|--------|
| 223 Rem / 5.56x45 mm NATO | Direct gas impingement | 16" | 35" | 1-9" | 7 lbs |



A3 ENTRY CARBINE
90260

| CALIBER | OPERATION | BARREL LENGTH | OVERALL LENGTH | TWIST | WEIGHT |
|-------------------|------------------------|---------------|----------------|-------|---------|
| 5.56 x 45 mm NATO | Direct gas impingement | 11.5" | 30" | 1-9" | 6.7 lbs |



M4 CARABINE
90274

| CALIBER | OPERATION | BARREL LENGTH | OVERALL LENGTH | TWIST | WEIGHT |
|---------------------------|------------------------|---------------|----------------|-------|---------|
| 223 Rem / 5.56x45 mm NATO | Direct gas impingement | 14.5" | 35" | 1-9" | 6.3 lbs |



A3 AUTO ENTRY
90468

| CALIBER | OPERATION | BARREL LENGTH | OVERALL LENGTH | TWIST | WEIGHT |
|---------------------------|------------------------|---------------|----------------|-------|---------|
| 223 Rem / 5.56x45 mm NATO | Direct gas impingement | 11.5" | 30.5" | 1-9" | 6.7 lbs |



PATROLMAN'S CARBINE A3
90481

| CALIBER | OPERATION | BARREL LENGTH | OVERALL LENGTH | TWIST | WEIGHT |
|---------------------------|------------------------|---------------|----------------|-------|---------|
| 223 Rem / 5.56x45 mm NATO | Direct gas impingement | 16" | 35" | 1-9" | 7.3 lbs |



AR15/AR10 TRIGGERS

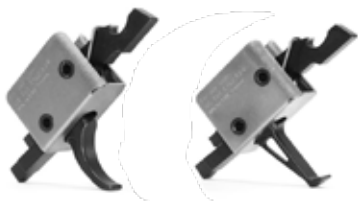

CMC SINGLE STAGE TRIGGER

CMC Triggers innovative, self-contained, and easy-to-install AR-15/10 Single trigger groups, have been completely re-tooled to maximize production capacities.

91502



CMC TWO STAGE TRIGGER

Inspired by the 1911 pistol, CMC's Two Stage Drop-in Trigger module provides all the advantages of a fine, match-grade trigger without the hand-fitting and trial-and-error.

91504

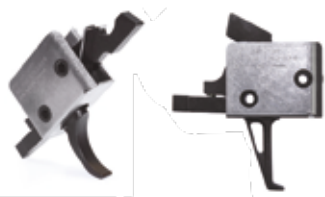

CMC COMPETITION TRIGGER

Answering the demand from the nations top 3 Gun competitive shooters for a lighter trigger, the new Single Stage 2.5 lbs pull Competition Drop-in Trigger Group is CMC's solution.

90501

PCC TRIGGER

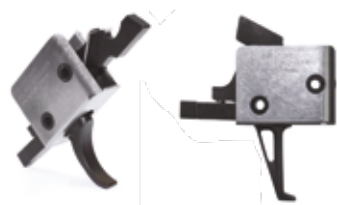

CMC 9 MM PCC TRIGGER

Due to the rise in popularity of Pistol Caliber Carbine rifles and after careful research and development, CMC Trigger recently launched their CMC 9 mm PCC Drop-in Trigger.

95503

PISTOL TRIGGER KIT



CMC GLOCK DROP-IN TRIGGER

The CMC Glock replacement trigger is a drop-in unit that improves the trigger's overall performance while reducing the pull weight. Utilizing CMC's patented "Signature" Flat Trigger design.

71501

PARTS



CMC GLOCK MATCH PRECISION BARRELS

CMC's New Gas Block is a low and narrow, one-piece block designed to fit inside most free-float hand guards. Designed to allow rifle length forearms on carbine length barrels for a clean, streamlined look and added gripping surface.

81611



CMC NITRIDE COATED GAS TUBES

The Nitride Coated Gas Tube is an essential component for the AR-15 family of firearms. Precision machined from 304 Stainless Steel, CMC Triggers AR15/AR10 gas tubes have an extremely durable Nitride finish that increases corrosion resistance.

81622



CMC GLOCK MATCH PRECISION BARRELS

CMC complete lower receiver parts kit for AR-15 is a great addition to your AR15 build. From amateur gun builder to seasoned expert gunsmith, this lower parts kit is for you.

81500



CARBINE BUFFER TUBE KIT ENHANCED QD

CMC's six-position AR-15 buffer tube machined from 7075 T6 aluminum to Mil-Spec dimensions with a Type III, Class II hard coat anodized finish. Buffer tube has through drainage holes to allow water to evacuate in submerged environments.

81626



CMC M-LOK KIT

The low-profile M-LOK QD Sling Mount features beveled edges to reduce snagging and has an anti-rotation design that prevents swivels from spinning • Available M-LOK 3, 5 and 7 slot Picatinny rail.

81721



CMC ANTI-WALK PIN SETS

CMC Anti-walk pin sets are ideal for use with all CMC AR-15/10 Drop-in Trigger Groups, along with traditional AR trigger groups.

91401

BARRELS

CMC GLOCK MATCH PRECISION BARRELS

CMC's match precision barrels are the ultimate upgrade drop-in barrels for Gen 3 & 4 Glock 17,19 and 34 pistols. Match grade barrels are precision machined from Certified, DFARS compliant; pre-hardened 416R premium grade stainless steel, to extremely tight tolerances and exacting details. 416R stainless steel, recognized for its corrosion resistance, machinability, and high tensile strength, is the industry standard for premium match grade barrel manufacturing.

75513



FEATURES

- User friendly drop-in, no gunsmith required
- Straight Fluted
- Bead blasted to create satin finish prior to plating
- 6 grooves, cut rifled, 1:10 Twist Right Hand
- SAAMI, Match Grade chambers, precision cut hBN bore and chamber
- Stainless, uniform Satin Blast Finish with ultra- low friction HxBNB ore & Chamber
- Bronze TiCN, with ultra low friction hBN Bore & Chamber
- Black DLC, with ultra low friction hBN Bore & Chamber
- 17 and 19 available with or without suppressor threads in 1/2-28 TPI RH



DPMS
PANTHER
ARMS™

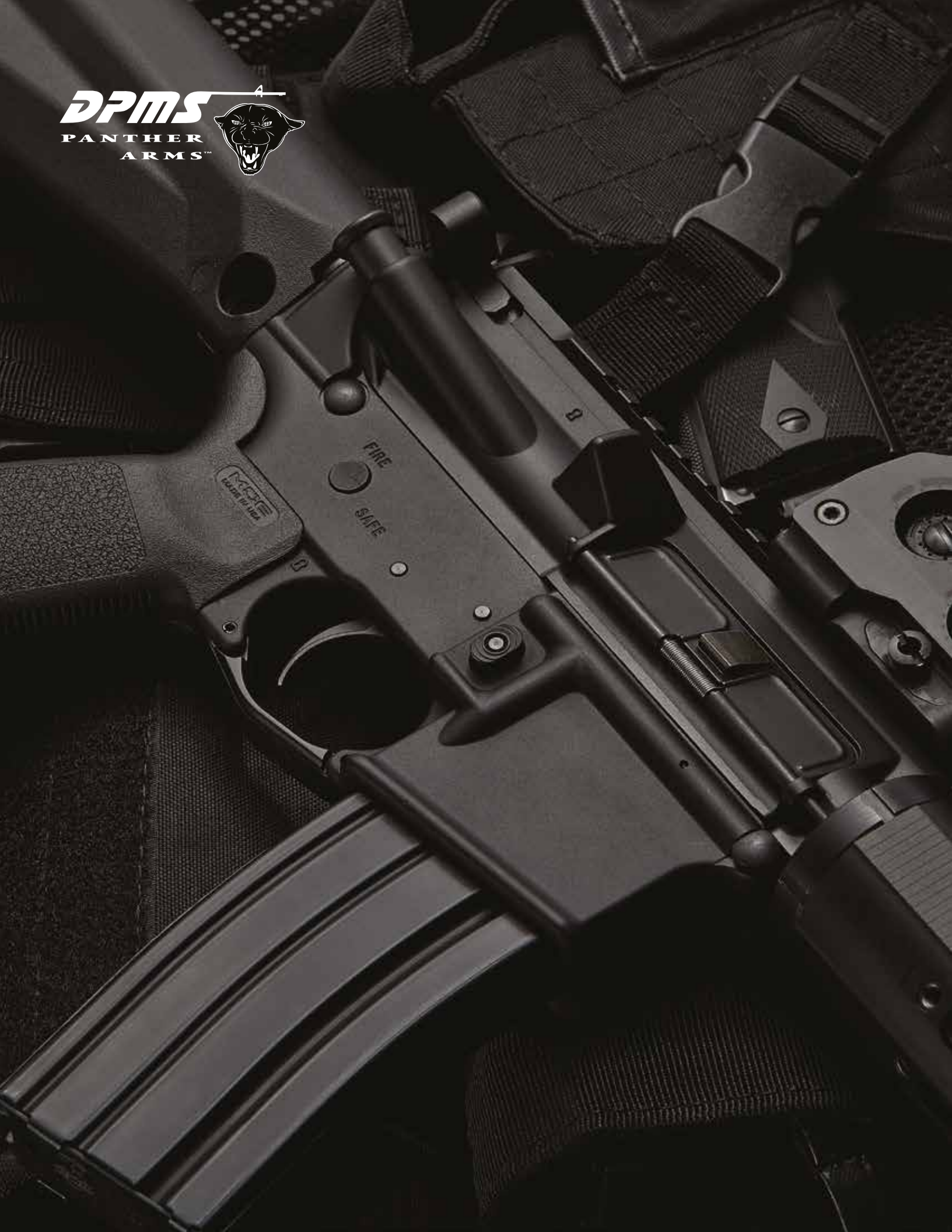



DPMS M-LOK TAC2, A3 UPPER, 16"
60259

| CALIBER | WEIGHT | LENGTH | BARREL | TWIST |
|-----------------|----------|------------|--------|-------|
| 5.56x45 mm NATO | 8.50 lbs | 34.25"/38" | 16" | 1-9" |



LITE 16M, A3 UPPER, 16"
60218

| CALIBER | WEIGHT | LENGTH | BARREL | TWIST |
|-----------------|----------|--------------|---------------|-------|
| 5.56x45 mm NATO | 7.50 lbs | 33.75"/37.5" | 16" 4140 HBAR | 1-9" |



M-LOK TPR
60260

| CALIBER | WEIGHT | LENGTH | BARREL | TWIST |
|-----------------|----------|--------------|--------|-------|
| 5.56x45 mm NATO | 7.75 lbs | 37.25"/40.5" | 20" | 1-9" |



MINI SASS
60544

| CALIBER | WEIGHT | LENGTH | BARREL | TWIST |
|-----------------|-----------|-------------|--------|-------|
| 5.56x45 mm NATO | 10.25 lbs | 38.5"/39.5" | 18" | 1-8" |



ORACLE
60560-ATACS

| CALIBER | WEIGHT | LENGTH | BARREL | TWIST |
|---------------------|---------|---------------|--------|-------|
| 308 Win / 7.62 NATO | 8.3 lbs | 32.5" / 36.5" | 16" | 1-10" |



RECON
60542

| CALIBER | WEIGHT | LENGTH | BARREL | TWIST |
|-----------------|----------|--------------|--------|-------|
| 5.56x45 mm NATO | 7.65 lbs | 33.25" - 37" | 16" | 1-9" |



ORACLE
60531

| CALIBER | WEIGHT | LENGTH | BARREL | TWIST |
|-----------------|---------|---------------|--------|-------|
| 5.56x45 mm NATO | 6.4 lbs | 32.5" / 36.5" | 16" | 1-9" |



TACTICAL PRECISION RIFLE
60546

| CALIBER | WEIGHT | LENGTH | BARREL | TWIST |
|-----------------|----------|----------------|--------|-------|
| 5.56x45 mm NATO | 7.75 lbs | 37.25" / 40.5" | 20" | 1-9" |



TAC 2
60545

| CALIBER | WEIGHT | LENGTH | BARREL | TWIST |
|-----------------|----------|------------|--------|-------|
| 5.56x45 mm NATO | 8.50 lbs | 34.25"/38" | 16" | 1-9" |



5.56 LCAR
60140

| CALIBER | WEIGHT | LENGTH | BARREL | TWIST |
|-----------------|---------|--------|--------|-------|
| 5.56x45 mm NATO | 6.4 lbs | 36.5" | 16" | 1-8" |



AP4 CARBINE
60505

| CALIBER | WEIGHT | LENGTH | BARREL | TWIST |
|-----------------|----------|---------------|--------|-------|
| 5.56x45 mm NATO | 7.15 lbs | 32.5" / 36.5" | 16" | 1-9" |



LITE 16 A3
60525

| CALIBER | WEIGHT | LENGTH | BARREL | TWIST |
|-----------------|---------|---------------|--------|-------|
| 5.56x45 mm NATO | 6.0 lbs | 32.5" / 36.5" | 16" | 1-9" |



LBR CARBINE
60527

| CALIBER | WEIGHT | LENGTH | BARREL | TWIST |
|-----------------|----------|--------------|--------|-------|
| 5.56x45 mm NATO | 7.25 lbs | 33" / 36.75" | 16" | 1-9" |



3G1
60521

| CALIBER | WEIGHT | LENGTH | BARREL | TWIST |
|-----------------|----------|-----------|--------|-------|
| 5.56x45 mm NATO | 7.75 lbs | 35" / 39" | 18" | 1-8" |



300 BLACK SILENCER READY
60520

| CALIBER | WEIGHT | LENGTH | BARREL | TWIST |
|------------------|--------|--------------|--------|-------|
| 300 AAC Blackout | 7 lbs | 31.25" / 37" | 16" | 1-7" |



DPMS MOE SL CARBINE
60529

| CALIBER | WEIGHT | LENGTH | BARREL | TWIST |
|---------------------|---------|--------|--------|-------|
| 223 Rem / 5.56 NATO | 7.3 lbs | - | 16" | 1-7" |



GII .308 AP4-OR, OPTICS READY
60224

| CALIBER | WEIGHT | LENGTH | BARREL | TWIST |
|---------------------|----------|--------|--------|-------|
| 308 Win / 7.62 NATO | 7.25 lbs | 34.25" | 16" | 1-10" |



GII AP4 RIFLE
60220

| CALIBER | WEIGHT | LENGTH | BARREL | TWIST |
|---------------------|----------|--------|--------|-------|
| 308 Win / 7.62 NATO | 7.25 lbs | 34.25" | 16" | 1-10" |



GII .308 MOE RIFLE
60232

| CALIBER | WEIGHT | LENGTH | BARREL | TWIST |
|---------------------|----------|--------|--------|-------|
| 308 Win / 7.62 NATO | 7.25 lbs | 34.25" | 16" | 1-10" |



GII .308 RECON
60222

| CALIBER | WEIGHT | LENGTH | BARREL | TWIST |
|---------------------|---------|--------|--------|-------|
| 308 Win / 7.62 NATO | 8.5 lbs | 38" | 16" | 1-10" |



DPMS G2 SASS
60230

| CALIBER | WEIGHT | LENGTH | BARREL | TWIST |
|---------------------|----------|--------|--------|-------|
| 308 Win / 7.62 NATO | 10.5 lbs | 39" | 18" | 1-10" |



DPMS G2 BULL 24'
60236

| CALIBER | WEIGHT | LENGTH | BARREL | TWIST |
|---------------------|--------|--------|--------|-------|
| 308 Win / 7.62 NATO | 10 lbs | 43" | 24" | 1-10" |



GII HUNTER
60238

| CALIBER | WEIGHT | LENGTH | BARREL | TWIST |
|---------------------|----------|--------|--------|-------|
| 308 Win / 7.62 NATO | 7.76 lbs | 39" | 20" | 1-10" |



GII .308 RECON
60558

| CALIBER | WEIGHT | LENGTH | BARREL | TWIST |
|------------------------|--------|--------|--------|-------|
| 308 Win / 7.62x51 NATO | - | - | 16" | 1-10" |



GII COMPACT HUNTER
60556

| CALIBER | WEIGHT | LENGTH | BARREL | TWIST |
|---------------------|---------|--------|--------|-------|
| 308 Win / 7.62 NATO | 6.9 lbs | 32" | 18" | 1-10" |



PRAIRIE PANTHER KUIU VERDE
60205

| CALIBER | WEIGHT | LENGTH | BARREL | TWIST |
|---------------|----------|--------|--------|-------|
| 223 Remington | 7.15 lbs | 38.5" | 20" | 1-8" |



PRAIRIE PANTHER TRUETIMBER
60207

| CALIBER | WEIGHT | LENGTH | BARREL | TWIST |
|---------------|----------|--------|--------|-------|
| 223 Remington | 7.15 lbs | 38.5" | 20" | 1-8" |



BULL 24
60508

| CALIBER | WEIGHT | LENGTH | BARREL | TWIST |
|---------------|---------|--------|--------|-------|
| 223 Remington | 9.8 lbs | 42.5" | 24" | 1-9" |

GII FEATURES

WHAT SETS THE GII APART? EVERYTHING.

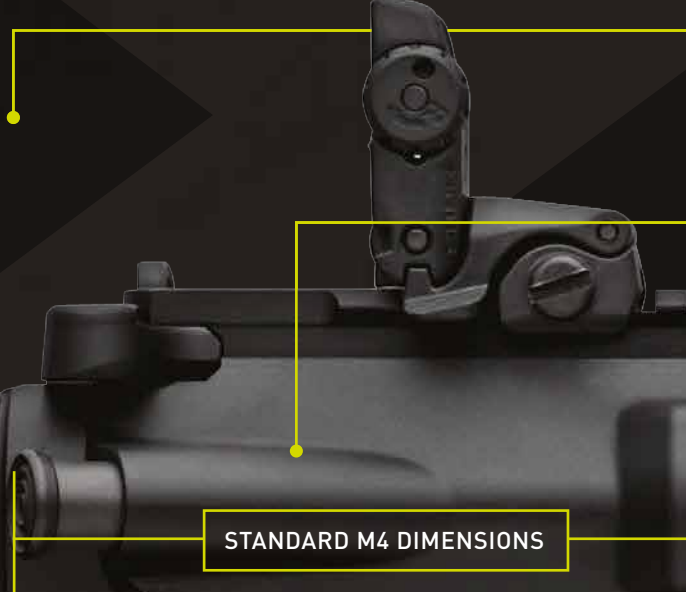

STANDARD M4 DIMENSIONS



STANDARD AR FIRE CONTROL AND
TAKE DOWN COMPONENTS.
IMPROVED HAMMER & TRIGGER PINS

GII IMPROVEMENT RESULT

- + RELIABILITY
- + LIGHTWEIGHT
- + IMPROVED HANDLING
- + INCREASED DURABILITY
- + LONGEVITY
- + VERSATILITY
- + ADAPTABILITY



FORGED LOWER RECEIVER
WITH INTEGRAL ENHANCED
TRIGGERGUARD

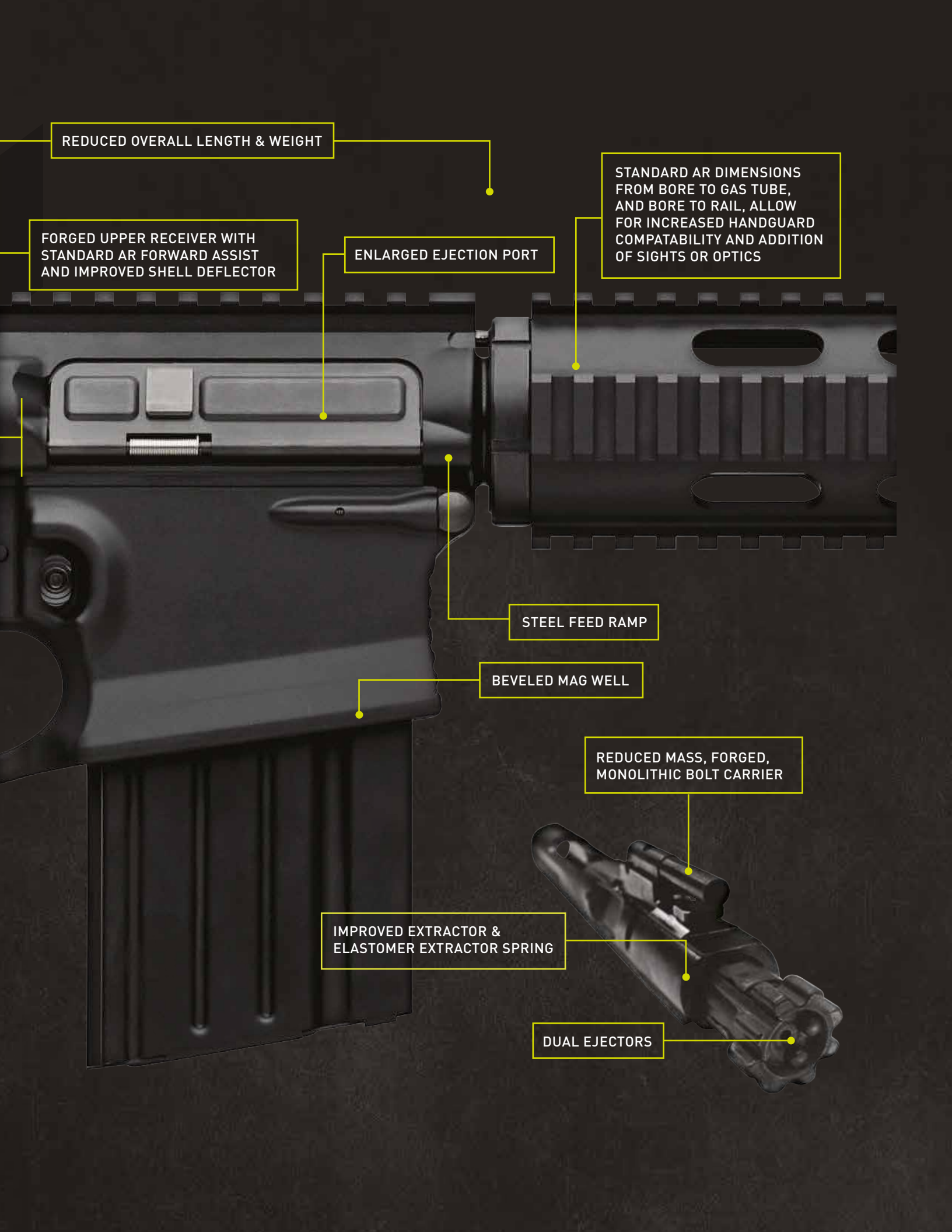

REDUCED OVERALL LENGTH & WEIGHT

FORGED UPPER RECEIVER WITH STANDARD AR FORWARD ASSIST AND IMPROVED SHELL DEFLECTOR

ENLARGED EJECTION PORT

STANDARD AR DIMENSIONS FROM BORE TO GAS TUBE, AND BORE TO RAIL, ALLOW FOR INCREASED HANDGUARD COMPATABILITY AND ADDITION OF SIGHTS OR OPTICS

STEEL FEED RAMP

BEVELED MAG WELL

REDUCED MASS, FORGED, MONOLITHIC BOLT CARRIER

IMPROVED EXTRACTOR & ELASTOMER EXTRACTOR SPRING

DUAL EJECTORS

UPPER BARREL ASSEMBLIES



Lite A3 upper barrel assy • Twist: 1x9 • A3 flat-top • Barrel: 16" 4150 chrome lined • 5.56x45 NATO • A2 front sight • Glacier guards

60572



16" GII .308 AP4 • Glacier guard • 16" Lightweight 4150 Chromelined • Twist: 1x10 • .308 / 7.62 NATO • 16" 4150 chrome lined

60650



Brl assy 5.56 Tac 2 • Standard length M111 free • Float a frame front sight/ Magpul MBUS rear • 16" 4150 chrome lined (dissipator) • Twist: 1x9

60588



Brl Assy .300 AAC 16" Suppressor • Twist: 1x7 • A3-style 7075-T6 aluminum flat top receiver with sixteen inch heavy

60575



16" .308 Oracle • Twist: 1x10 • Extruded 7029 T6 A3 flattop • Railed gas block/optics ready • Glacier guards • A2 FH

60603



TPR 5.56 Tactical Pre • 20" heavy barrel • Twist: 1x9 • Flash hider: AAC • Extruded 7029 T6 A3 flattop • Handguard: M111

60624



20" GII .308 Hunter • Twist: 1x10 • .308 / 7.62 NATO • Forged 7075 T6 Lvl 3 anodized, Teflon coated A3 type

60649



Bull barrel for Remington 223 A3 • Stainless steel • Twist: 1x9 • Barrel: 24" 4150 chrome lined

60590



Barrel assy • Prairie panther B • .223 Rem • Carbon fiber free float • Target crown • 20" SST black light weight • Twist: 1x8

60586



3-Gun • 18" 416 stainless bull • 5.56x45 mm NATO • 12" VTAC modular rail, free float • Twist: 1x8 • Extras: Single rail gas block, dual sling swivel studs

60576



24" GII .308 bull • 24" 416 stainless bull • .308 / 7.62 NATO • Forged 7075 T6 Lvl 3 anodized, Teflon coated • Twist: 1x10

60651



5.56 recon stainless steel blasted • 4 rail mid length free float • Magpul sights • AAC • 16" SST bead blasted mid length

60592



5.56 LBR barrel assy • A3-style 7075-T6 aluminum flat top receiver with sixteen inch heavy • Barrel: 16" 4150 chrome lined

60583



AR-15 A3 bull barrel for Remington 223 • Free floated • 16" 416 stainless steel • Twist: 1x9 • A2 forged

60591



5.56 recon stainless steel blasted • 4 rail mid length free float • Magpul sights • AAC • 16" SST bead blasted mid length

60587

LOWER RECEIVERS



5.56 NATO • Assembled receiver includes: Fully assembled DPMS lower receiver, A2 pistol grip & your choice of any of these featured buttstock assemblies

60593



5.56 NATO • A2 Buttstock • Assembled receiver includes: Fully assembled DPMS lower receiver, A2 pistol grip & your choice of any of these featured buttstock assemblies

60594



5.56 NATO stripped lower receiver assembly with out stock • Assembled receiver includes: A2 pistol grip & your choice of any of these featured buttstock assemblies

60596



5.56 NATO • Pardus 6-position telescoping stock assembly • Assembled receiver includes: Fully assembled DPMS lower receiver & your choice of any of these featured buttstock assemblies

60597



7.62 NATO • Gen II AP4 6-position telescoping assembled lower receiver • Assembled lower: Fully assembled 7.62 DPMS lower receiver & your choice of any of these featured buttstock assemblies

60648



5.56 NATO • Stripped lower receiver • Stripped receiver features: Hard coat anodized per Mil-Spec and Teflon coated black • FFL required for purchase • Forged 7075-T6 aircraft aluminum alloy

60660

MAGAZINES



7.62 NATO • .308 magazine • 20-round capacity • For use with: 243 Win, 260 Remington, 308 Win, 338 Fed, 6.5 CM

60667



7.62 NATO • .308 magazine • 10-round capacity • For use with: 243 Win, 260 Remington, 308 Win, 338 Fed, 6.5 CM

60666



7.62 NATO • .308 magazine • 4-round capacity • For use with: 243 Win, 260 Remington, 308 Win, 338 Fed, 6.5 CM

60725

ACCESSORIES AND PART KITS



The .308 miculek comp (kit) designed by world renowned shooter Jerry Miculek.

60669



Six opposing side ports direct gasses outward to reduce muzzle jump.

60673



Retail pack 308 Gen I and Gen II extractor and elastomer spring kit.

60700



EOTECH.



MODEL HHS I

EXPS3-4 WITH A G33-ST5 MAGNIFIER

The Holographic Hybrid Sight I (HHS I), featuring an EXPS3-4 with a G33 magnifier, provides a solution for engaging threats in Close Quarters Combat situations and then quickly to 600-meter targets. Instant transition is achieved through a Switch-To-Side (STS) mount that offers a simple and quick disengagement of the magnifier. This durable, night vision-compatible system offers wide field optical performance for visibility in extreme low-light conditions.

HHS I



FEATURES

- L x W x H: 7.7" x 2.3" x 3.3" (195.6 x 59 x 83.9 mm)
- Weight: 22.4 oz (635.1 g)
- Water-resistant: To 33 ft. (10 m)
- Mount: MIL-STD-1913 rail or 1" weaver
- Fixed magnification: 3X
- Brightness: 30 settings (10 NV settings)
- Power source: 1 x 123 lithium battery
- Battery life: 600 continuous hrs at nominal setting 12
- G33-sts is compatible with all Eotech sights

MODEL GREEN

EXPS2-0 GREEN RETICLE WITH A G33-ST5 MAGNIFIER

Regardless of the scenario, the Holographic Hybrid Sight Green (HHS GREEN), featuring an EXPS2-0GRN with a G33 magnifier, provides an amazing advantage when transitioning from close quarter to long-range shooting. Instant transition is achieved through a quick Switch-To-Side (STS) mount that offers a simple, quick disengagement of the magnifier. The Green reticle is approximately 6X easier to see than red in daytime which can lead to faster target acquisition.

G33.ST5



FEATURES

- L x W x H: 7.7" x 2.3" x 3.3" (195.6 x 59 x 83.9 mm)
- Weight: 22.4 oz (635.1 g)
- Water-resistant: To 10 ft. (3 m)
- Mount: 1" Weaver or MIL-STD-1913 rail
- Magnification fixed: 3X
- Brightness: 20 settings (10 NV settings)
- Power source: 1 x 123 lithium battery
- Battery life: 600 continuous hrs at nominal setting 12

NIGHT VISION



MODEL M914

NIGHT VISION DEVICE

The M914 weapon sight is one of the most versatile night vision systems available today. It can be used as a handheld pocket scope, a helmet-mounted monocular, or a weapon sight when mounted in tandem with an infrared laser aimer or other night vision-compatible primary optic, such as an Eotech HWS. Additional features include a low-battery indicator located in the eyepiece and an active projected infrared LED that provides short-range illumination for activities such as map reading.

245620-005



FEATURES

- L x W x H: 4.5" x 2.5" x 2.4"
- Weight: 350 g (0.77 lbs) with battery
- Magnification: 1X
- Field-of-view: 40°
- Objective lens: 1.1" (27 mm)
- Min focus distance: 9.8" (27 mm)
- Eye relief: 1" (25 mm)
- Diopter adjustment: +2 to -6
- Power source: 1 x AA battery
- Battery life (at room temp.): Approx. 40 hrs

MODEL M2124

CLIP-ON NIGHT VISION DEVICE

The M2124 is a rugged, Clip-On Night Vision Device (CNVD) based on the military AN/PVS-24 nomenclature. The advanced design of the M2124 eliminates the typical requirement of removing a primary (day) sighting system since the CNVD mounts in line with a standard day optical sight. Combining day and night vision sights eliminates the need to re-zero, as the primary sight remains undisturbed. Additional advantages to supplementing a primary sighting system with the M2124 include maintaining a user's consistent eye relief and shooting position, as well as retaining user muscle memory.

39108100-008



FEATURES

- L x W x H: Call factory for details
- Weight: 794 g (1.75 lbs) with battery
- Magnification: 1X
- Field-of-view: 13°
- Min focus distance: 27.3 yds. (25 m)
- Detection range: 546.8 yds. (500 m)
- Power source: 1x123 lithium battery
- Battery life (at room temp.): Approx. 16 hrs.

MODEL M2124 LR

CLIP-ON NIGHT VISION DEVICE - LONG RANGE

The M2124LR is a slightly larger version of the M2124 with a 8-degree field-of-view that is optimized to partner with 4x-20x magnified riflescopes. Combining day and night vision sights eliminates the need to re-zero, as the primary sight remains undisturbed.

39115150-ML001TP



FEATURES

- L x W x H: Call factory for details
- Weight: 1,025 g (2.25 lbs) with battery
- Magnification: 1X
- Field-of-view: 8°
- Objective lens: 4.3" (110 mm)
- Min focus distance: 43.8 yds. (40 m)
- Detection range: 929.6 yds. (850 m)
- Power source: 1x123 lithium battery
- Battery life (at room temp.): Approx. 16 hrs.

MODEL 300 BLK

300 BLACKOUT

Designed with tactical shooters in mind, the XPS2-300 offers a two-dot ballistic drop reticle that allows the shooter to zero either Subsonic or Supersonic 300 Blackout rounds in the same reticle pattern. Offered in the XPS2 platform, it features a 300 BLK custom laser etching on the hood and water-resistant capability up to 10 feet, functionality and durability are at the forefront.

XPS2-300



RETICLE

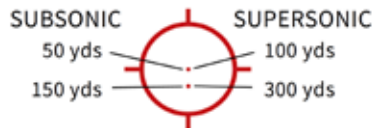

FEATURES

- L x W x H: 3.8" x 2.1" x 2.5"
- Weight: 9.0 oz (255 g)
- Water-resistant: To 10 ft. (3 m)
- Mount: 1" Weaver or MIL-STD-1913 rail
- Brightness: 20 settings
- Power source: 1 x 123 lithium battery
- Battery life: 600 continuous hrs at nominal setting 12

MODEL EXPS3

EXPS3

The Holographic Hybrid Sight I (HHS I), featuring an EXPS3-4 with a G33 magnifier, provides a solution for engaging threats in Close Quarters Combat situations and then quickly to 600-meter targets. Instant transition is achieved through a Switch-To-Side (STS) mount that offers a simple and quick disengagement of the magnifier. This durable, night vision-compatible system offers wide field optical performance for visibility in extreme low-light conditions.

EXPS3-0



FEATURES

- L x W x H: 3.8" x 2.1" x 2.5"
- Weight: 11.2 oz (317 g)
- Water-resistant: To 33 ft. (10 m)
- Mount: Quick-detach lever fits both 1" weaver
- Brightness: 20 daylight settings and 10 night vision sightings
- Power source: 1 x 123 lithium battery
- Battery life: 600 continuous hrs at nominal setting 12

VUDU 3.5-18X50 PRECISION RIFLE SCOPE

MODEL VUDU

The Vudu 3.5-18x provides a robust 34 mm tube, XC High-Density glass, and is loaded with other performance features required to take that precise long-range shot. The oversized and precision-machined turrets, with EZ Chek Zero Stop feature, lets you quickly dial adjustments and return to zero, even in low-light conditions. The side-mounted parallax adjustment allows you to easily dial-in the reticle focus for the most difficult long-range shots.

VDU3-18FFH59

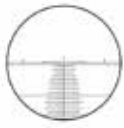

HORUS H59



MD1-MRAD



MD2-MOA

FEATURES

- Overall length: 377 mm (14.841 in)
- Weight W/ battery: 952 g (33.6 oz)
- Actual magnification: 3.5x - 18x
- Exit pull: 3.5X: 11.2 mm / 18X: 2.8 mm
- Eye relief: 3.5X: 91-101 mm / 18X: 90-101 mm
- Actual field-of-view: 3.5X: 86-100 mm / 18X: 88-99 mm
- Field-of-view: 3.5x: 9.2 m (29.5 ft.) / 18x: 1.8 m (5.7 ft.)
- Battery life: Approx. 500 hrs.
- Focal plane: First focal plane / Second focal plane

VUDU 1-6X24 PRECISION RIFLE SCOPE

MODEL VUDU

Compact, yet fully loaded. This is an optic that feels as much at home on the AR platform as it does on your favorite bolt action rifle. The EOTech Speed Ring reticle allows for fast target engagement at low power, but at higher power provides the resolution and accuracy required to tackle longer shots. The Vudu 1-6x is the perfect solution for short-to medium-range applications that require the highest level of durability and accuracy.

VDU1-6FFSR1

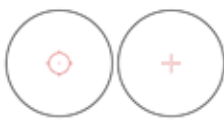

SR-1 (MRAD)

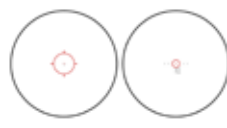

SR-2 (7.62 mm BDC)
SR-3 (5.56 mm BDC)
(MOA)

FEATURES

- Overall length: 270 mm (10.63 in)
- Weight W/ battery: 570 g (20.1 oz)
- Actual magnification: 1x - 6x
- Exit pull: 1X: 11.2 mm / 6X: 2.8 mm
- Eye relief: 1X: 91-101 mm / 6X 90-101 mm
- Actual field-of-view: 1x: 86-100 mm / 6X: 88-99 mm
- Field-of-view: 1x: 9.2 m (29.5 ft.) / 6x: 1.8 m (5.7 ft.)
- Battery life: Approx. 500 hrs.
- Focal plane: First focal plane / Second focal plane

HOLOGRAPHIC SIGHTS AND SCOPES



MODEL EXP52 Green

Achieve faster target acquisition with the new easy-to-see Green reticle that is approximately 6X easier to see than red in daytime.

EXP52-0GRN



MODEL XPS2 GREEN

The XPS2 is the shortest, smallest and lightest Eotech holographic weapon sight available.

XPS2-0



MODEL XPS2

The XPS2 is the shortest, smallest and lightest Eotech model holographic weapon sight available without night vision.

XPS2-2



MODEL 512

Model 512 is our most popular holographic weapon sight. It's ideal when you need the best in speed and versatility.

512.A65



MODEL 518

The 518 runs on easy to find AA batteries but offers all of the features found in EOTech's EXP5 top of the line sight.

518.A65



MODEL XPS3

The XPS3 is smaller and lighter than all other holographic weapon sights but just as fast.

XPS3-0



MODEL HHS II

The Holographic Hybrid Sight II (HHS II) has an EXP52-2 with a G33.STS magnifier. Regardless of the scenario, it provides an unparalleled advantage when transitioning from short-range to long-range shooting.

HHS II



MODEL HHS III

The HHS III is extremely versatile. It offers quick close quarter targeting with the magnifier switched away but can instantly transition to a magnified optic effective out to longer distances.

HHS III



MODEL HHS-GREEN

The Holographic Hybrid Sight II (HHS II) has an EXP52-0 with a G33.STS magnifier. Regardless of the scenario, it provides an unparalleled advantage when transitioning from short-range to long-range shooting.

HHS-GRN



VUDU 5-25X50 PRECISION

The New Vudu 5-25 x 50 mm is ideal for the short platform rifles. At approximately 11.2 inches in length, the 5-25x is one of the shortest first focal plane rifle scopes on the market.

VDU5-25FFH59



VUDU 2.5-10X PRECISION

The 2.5-10x Vudu rifle scopes provide the perfect combination of speed and accuracy to tackle those tough shots.

VDU2-10FFMD1



LIGHT WEAPON THERMAL SIGHT

The Light Weapon Thermal Sight (LWTS) is an extremely versatile thermal imaging solution.

TWB-001-A3

OEM PARTS



COMPLETE MOUNTING HANDGUARD KIT

Complete mounting hardware for the Eotech 511/512/551/552

9-EOTECH-MTGKT



HARD CASE

Eotech replacement hard case w/ foam insert.

N-2615



SHIFT-TO-SIDE G33 MAGNIFIER MOUNT

The kit includes screws, 7 mm riser plate, thread lock, and instructions.

9-G33STS



511/551 BATTERY COMPARTEMENT

Battery compartment for the Eotech 511/551 using N-Cell style batteries.

9-N1044



512/552 BATTERY COMPARTEMENT

Battery compartment for the Eotech 512/552 (Post-2009).

9-N1045



511/512/551/552 REPLACEMENT HOOD KIT

Replacement hood kit for Eotech HWS models 512, 552, 511 and 551 sights. Includes replacement hood and screws.

9-N1063



511/512/551/552 CONTACT REPLACEMENT KIT

Eotech Genuine 511, 551, 512 and 552 contact replacement kit services worn or oxidized contacts.

9-NBUMPER



EXPS/XPS REPLACEMENT BATTERY CAP KIT

Battery compartment for the Eotech EXPS/XPS with Tether.

9-XP1199



COMPARTMENT REPAIR KIT

Battery Compartment repair kit for the Eotech 512/552 (Pre-2009).

9-2107A

A LEADER IN IMAGING SYSTEMS



PISTOL GRIPS



2 AR SUREGRIP

Very similar in size to the 4009 and 4011. The 4010 is slightly more rounded in the back.

4010-BK



TACTICAL DELUXE FLAT TOP

The tactical deluxe flat top takes comfort and control to a new level.

4035-BK



TACTICAL DELUXE GRIP W/ PALM SHELF

The tactical deluxe flat top with palm shelf takes comfort and control to a new level.

4055-BK



THE ORIGINAL ERGO AT

The original Ergo AT was the first truly ergonomic, shooter focused grip for AR platform rifles.

4000-BK



THE ORIGINAL ERGO

The original Ergo was the first truly ergonomic, shooter focused grip for AR platform rifles.

4011-BK



THE ORIGINAL ERGO RIGID

The original Ergo Grip Rigid, was the first truly ergonomic, shooter focused grip for AR platform rifles.

4015-BK



TACTICAL DELUXE GRIP

Fits AR type firearms in .223 and .308 • Over molded suregrip material with heavy texture.

4045-BK



FLAT TOP TACTICAL DELUXE

The gripping surface of this grip is the same size at the 4045 Tactical Deluxe.

4025-BK



2 FLAT TOP

A truly ergonomic, shooter focused flat top grip for AR platform rifles and chassis systems.

4014-BK



ERGO MSR

The ergo MSR, or modern sporting rifle, grip is perfect for shooters looking for an easy, bolt on upgrade for their standard AR grip.

4092-BK



ERGO SWIFT

The new Ergo Swift grip was designed for shooters who prefer or need to use a compact stance when shooting their rifle.

4093-BK



ERGO TDX-0

Ergo tactical deluxe zero angle grip • Designed for improved comfort and control on precision rifle chassis systems, AR-15/AR-10 platforms, and air guns.

4020-BK

FIREARM PARTS AND ACCESSORIES



DIAMOND PLATE

The Ergo Grip 15 slot diamond plate full rail cover provides a rubbery grip surface for improved weapon control.

4365-3PK-BK



LOWPRO LADDER RAIL

Add gripping surface with your rail cover and help protect rails in un-mounted areas • Available: 7, 15, 18 and 25 slots.

4378-3PK-BK



ERGO 5 SLOTS FULL COVER

Ergo full cover rail covers clip directly into Picatinny rails for full rail protection.

4360-3PK-BK



ARMORER BLOCK

This is one of the most useful maintenance accessories available for an AR-15.

4996



MINI MAX VERTICAL FORWARD

Ergo KeyMod Mini Max vertical forward grip in black • Mounts flush to KeyMod slots.

4231-BK



POP BOTTLE VERTICAL

Extremely durable, slide mounted, short polymer vertical forward grip • Injection molded vertical forward grip, extremely durable and tough.

4253-BK



M-LOK WEDGELOK RAIL

Rail covers fill in M-LOK slots to add additional grip. Comes in a handy 4-pack.

4332-4PK-BK



KEYMOD HAND STOP

Ergo KeyMod hand stop/barricade stop in black • Aggressive textured front for enhanced traction on barricades and obstacles.

4230-BK



AR-WEDGE

The Ergo AR Wedge is useful for reducing the amount of movement between the upper and lower receiver on an AR15.

4988



TACTICAL RAIL HAND STOP

Ergo Surestop tactical rail hand stop in black • Useful on short barrel rifles and shotguns. Can act as a hand positioning device • Dual Use, compatible with rifles and shotguns.

4201-SS-BK



SHOOTING PRODUCT



POCKET PRO II

SHOT CAPACITY: 99 shots

MAXIMUM TIME: 199.99 seconds (before wraparound)

WEIGHT: 5 ½ ounces

DISPLAY TYPE: ½" X 2" backlit graphics lcd

DIMENSIONS: 3" x 5" x 1 ½"

BATTERY LIFE: Approx. 20 hours of operation

BUZZER OUTPUT: 1,500 Hz

PROCHRONO PAL

DEBRIS SHIELD

INDOOR LIGHTING SYSTEM

PROCHRONO DLX



**Competition
Electronics**

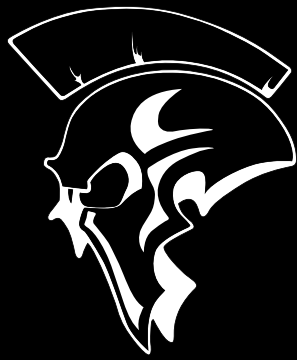

**ESTY
BREACHING**

MARY RAM

THE MARY RAM

The "Mary" ram was designed as a multipurpose tool. One end is designed to ram a door with a flat impact face, and at the opposite end is a proprietary, hardened and toothed two-prong fork. The flat ram side is used as an impact device to force open a door, and the other end acts as a pry tool and lock defeating mechanism. The forked end has specifically designed teeth inside the prongs that grab and secure shackles of locks, and through applied torque, cause the shackle to be broken.

MARY RAM



BESTY BAR

ESTY BETSY BAR

Betsy is made from alloy steel, built to last and destroy all that she comes across. Betsy is the red headed sister of the wrecking crew, Mary and Agnes the Destroyer Rams. Betsy is designed to destroy outward opening security screens with ease, pry padlocks with her patented teeth and destroy anything that needs some leverage to tip the scales of success in your favor.

BETSY BAR



CHUCK-E-TOOL

ESTY-CHUCK-E BELT TOOL

The Chuck-E-Tool is a 4130 heat treated steel belt tool. Designed and tested in the field to fit on most duty belts behind a keeper or magazine pouch. Have a quality strong pry bar with you when you need it. Designed to overcome security screen doors, gates, to work in conjunction with other tools to get you in when you need it most.

CHUCK-E TOOL



GEISSELE[®]
AUTOMATICS

CE
LUBRICANTS

GEISSELE
AUTOMATICS
SUPER DYNAMIC
ENHANCED

PATENT-GEISSELE.COM/PATENTS



TRIGGERS



SUPER 700

The Geissele Super 700 Trigger has been constructed from the ground up using the best quality materials to deliver an accurate and comfortable trigger. Completely adjustable, and a trigger pull weight between 12 ounces and 3.5 pounds, you can expect the Super 700 to deliver reliable and consistent results.

05-706



SUPER SEMI-AUTOMATIC

The Geissele super semi-automatic (SSA) trigger is a semi-automatic only version of Geissele Automatics's super select-fire trigger.

05-101



SUPER SEMI-AUTOMATIC ENHANCED

Built on the chassis of the Geissele SSA the super semi-automatic enhanced (SSA-E) provides enhanced trigger control.

05-160



SUPER DYNAMIC-ENHANCED

The Geissele super dynamic-enhanced featuring an exclusive flat trigger bow is a finely tuned 2 stage trigger providing enhanced trigger control.

05-167



SUPER DYNAMIC-ENHANCED

The SD-E trigger featuring an exclusive flat trigger bow, is a finely-tuned two stage trigger providing enhanced trigger control.

05-171



G2S

The Geissele 2 Stage (G2S) was designed to be a high quality, cost effective option of the SSA.

05-145



SUPER SPEED PRECISION

The Super Speed Precision (SSP) is Geissele Automatics first true single-stage trigger for the AR platform.

05-483

HANDGUARD AND UPPER RECEIVERS



16" SUPER MODULAR RAIL

The MK18 is the latest in the line of Geissele super modular rails and is specifically made to interface with the Arca-Swiss quick release system.

05-791B

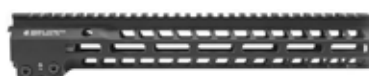

13" SUPER MODULAR RAIL

The MK14 is the latest entry to the Geissele line up of Super Modular rails.

05-573B



USASOC

For more than 50 years the famed silhouette of the M16/M4 has only had one major and several minor changes.

08-160

FIREARM PARTS AND ACCESSORIES



SUPER PRECISION HIGH-POWER

The super precision high-power rifle scope mount was specifically engineered to meet the strict demands of High-Power competitive shooting.

05-500B



SUPER PRECISION MRO

The Super Precision MRO Series was developed specifically to work with the Trijicon MRO and like mounted red dot optics.

05-544B



SUPER PRECISION HIGH-POWER

The Super Precision 1.93" scope mount was developed specifically for scenarios such as shooting while wearing a gas mask.

05-542B



SUPER PRECISION 30 MM

The Geissele AR-15/M4 Super Precision series of scope mounts are optimized for use with an AR-15/M4 upper.

05-549B



SUPER CHARGING HANDLE 5.56 MM

The Super charging handle is 3D machined from a solid block of aircraft grade 7075-T6 aluminum. Also compatible with HK 416 rifle.

05-313B



AIRBORNE CHARGING HANDLE

The Airborne Charging Handle (ACH) was developed at the request of an elite organization famous for its expertise in aerial insertion.

05-497B



SUPER PRECISION APT1

The Super Precision T1 Series was developed specifically to work with the Aimpoint T1 and similarly mounted red dot optics.

05-543B



ABSOLUTE CO-WITNESS

The Super Precision T1 series was developed specifically to work with the Aimpoint T1 and similarly mounted red dot optics.

05-401B



SUPER GAS BLOCK

The Geissele Super Gas Block is a low profile gas block is designed to fit under most free float rails.

05-807

FIREARM PARTS AND ACCESSORIES



TRIGGER FITTING PIN

The Geissele Trigger Fitting Pin is correctly sized to help with all small pin AR-15/AR-308 hammer and trigger installations.

02-313



AR10/SR25 REACTION ROD

The AR10/SR25 reaction rod makes the removal and installation of barrels, flash hiders, gas blocks and hand guards much easier and simpler.

10-247



ROLL PIN TOOL

The hole in the tip of the gas block roll pin tool is sized so that the roll pin will need to be pressed into the tool first.

10-225



5.56 MM SUPPRESSOR ALIGNMENT ROD

The Geissele Suppressor Alignment Rod (SAR) is a precision gauge used to verify the alignment of a suppressor to the bore of a firearm barrel.

10-259



MARITIME BOLT CATCH

The Geissele Maritime bolt catch is designed with the warfighter in mind and will work with any lower receiver designed to accept a mil-spec.

08-153



AR15/M4 SUPER REACTION ROD

The super reaction rod was designed with the advanced armorer in mind, an armorer.

15-193



PREMIUM MIL-SPEC BUFFER TUBE

The Geissele Premium Mil-Spec Buffer Tube is machined from quality 7075-T6 Aluminum and finished in Type 3 Hardcoat Anodize.

08-1635



ULTRA PRECISION

The Geissele Ultra Precision 5 Axis trigger guard is meticulously machined from 7075-T6 aluminum.

05-917B



PICATINNY RAIL FOR M-LOK

The Picatinny M-LOK rail sections are designed to interface with your M-LOK rail and will allow use of your favorite picatinny accessories, such as lights, lasers, grips, etc.

08-193B



BIPODS



BIPOD BRM-S FEATURES

Ultralight weights 13 oz • Extends from 6" to 9" • Leg notches in 1" increment • Legs are spring loaded, for fast deployment • Swivels (tilts) to compensate for uneven terrain • Has a built in sling swivel stud to attach the sling

BRM-S



BIPOD BR-S FEATURES

Ultralight weights 13 oz • Swivels (tilts) to compensate for uneven terrain • Has a built in sling swivel stud to attach the sling • Standard Legs

BR-S



BIPOD LM-S FEATURES

Ultralight weights 14 oz • Extend from 9" to 13" • Leg notches in 1" increments • Legs are spring loaded, for fast deployment • Swivels (tilts) to compensate for uneven terrain • Has a built in sling swivel stud to attach the sling

LM-S



BIPOD L-S FEATURES

Ultralight weights 13 oz • Extends from 9" to 13" • Swivels (tilts) to compensate for uneven terrain • Has a built in sling swivel stud to attach the sling • Standard Legs

L-S





SR-30 M-LOK
31970

| CALIBER | M-LOK COMPATIBLE | BARREL LENGTH | OVERALL LENGTH | TWIST | WEIGHT |
|-----------------------------|------------------|---------------|----------------|-------|---------|
| 300 Blackout (7.62 x 35 mm) | Yes | 9.5" (24 cm) | 26.75" - 30" | 1-7 | 6.2 lbs |



SR-25 CC M-LOK
31893

| CALIBER | M-LOK COMPATIBLE | BARREL LENGTH | OVERALL LENGTH | TWIST | WEIGHT |
|------------------------|------------------|----------------------|----------------|-------|---------|
| 7.62 mm NATO / 308 Win | Yes | 16" 5R Hammer Forged | 35.75" - 39.5" | 1-10 | 8.4 lbs |



SR-25 PC M-LOK
31955

| CALIBER | M-LOK COMPATIBLE | BARREL LENGTH | OVERALL LENGTH | TWIST | WEIGHT |
|------------------------|------------------|----------------------|----------------|-------|--------|
| 7.62 mm NATO / 308 Win | Yes | 16" 5R Hammer Forged | 35.75" - 39.5" | 1-10 | 9 lbs |



SR-25 PR M-LOK
31961

| CALIBER | M-LOK COMPATIBLE | BARREL LENGTH | OVERALL LENGTH | TWIST | WEIGHT |
|------------------------|------------------|---------------|----------------|-------|----------|
| 7.62 mm NATO / 308 Win | Yes | 20" (51 cm) | 39.75" - 43.5" | 1-10 | 10.5 lbs |



SR-15 LPR MOD-2 M-LOK
31973

| CALIBER | M-LOK COMPATIBLE | BARREL LENGTH | OVERALL LENGTH | TWIST | WEIGHT |
|--------------|------------------|---------------|----------------|-------|---------|
| 5.56 mm NATO | Yes | 18" (45 cm) | 35.25" - 38.5" | 1-7 | 7.4 lbs |



SR-25 CQB MOD-2 M-LOK
31952

| CALIBER | M-LOK COMPATIBLE | BARREL LENGTH | OVERALL LENGTH | TWIST | WEIGHT |
|--------------|------------------|---------------|----------------|-------|---------|
| 5.56 mm NATO | Yes | 11.5" (29 cm) | 29" - 32" | 1-7 | 6.1 lbs |

UPPER & LOWER ASSEMBLY KIT



6.5 CREEDMOOR SR-25 M-LOK
100223-BLK

| CALIBER | BARREL LENGTH | WEIGHT |
|------------------|--|---------|
| 6.5 mm Creedmoor | 22" (55.9 cm) Mid-weight Precision profile | 6.9 lbs |



SR-25 CC

The SR-25 14.5" Combat Carbine Upper kit is the latest evolution in the lightweight 7.62 mm NATO Carbine platform.

111468



SR-30 IWS

The ambi bolt release, selector lever, and magazine release offers left-handed users the ergonomic advantages inherent to AR15-based controls. 300 blackout / H2 buffer

31742



SR-15 IWS

The ambi bolt release, selector lever, and magazine release offers left-handed users the ergonomic advantages inherent to AR15-based controls. 5.56 Nato / H2 buffer

25780

MUZZLE DEVICES



5.56 MM QDC MAMS MUZZLE BRAKE KIT

The KAC 5.56 mm MAMS Brake has been engineered to increase controllability.

30168



7.62 MM MAMS KIT 3/4"-24 TPI

The KAC 7.62 mm MAMS Brake has been engineered to increase controllability Available in 3/4" - 24 TPI and 5/8".

30169



5.56 MM M4QD NT-4 MAMS

The KAC 5.56 mm MAMS Brake has been engineered to increase controllability.

32316

RAS

RAIL ADAPTER SYSTEM



M4 CARBINE RAS

Length: 6.25"
Weight: 8.9 oz
98064

M5 RIFLE RAS

Length: 11.5"
Weight: 14.4 oz
98065

FREE FLOAT RIFLE RAS

Length: 12"
Weight: 16.3 oz

URX 4

HANDGUARDS

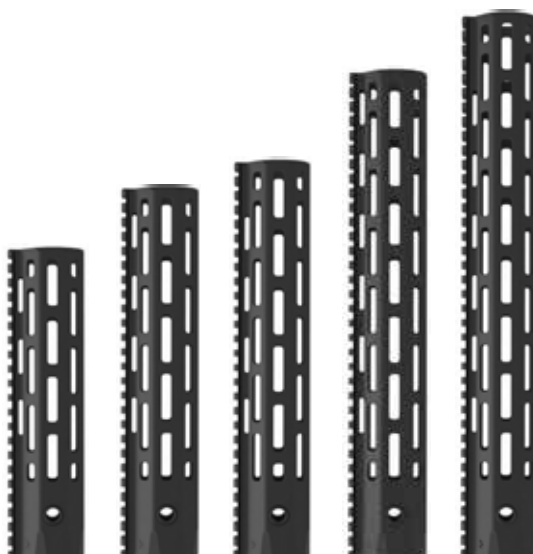

URX 4 5.56 M-LOK

Forend Kit, URX 4 5.56
Length: 8.5"
Weight: 8.96 oz
32304-0850

Forend Kit, URX 4 5.56
Length: 10"
Weight: 10.08 oz
32304-1000

Forend Kit, URX 4 5.56
Length: 10.75"
Weight: 10.2 oz
32304-1075

Forend Kit, URX 4 5.56
Length: 13.0"
Weight: 12.7 oz
32304-1300

Forend Kit, URX 4 5.56
Length: 14.5"
Weight: 13.8 oz
32304-1450

URX 3 & 3.1

HANDGUARDS

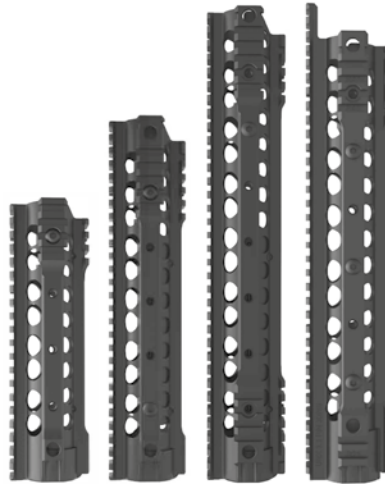

| URX 3 | URX 3.1 | URX 3.1 | URX 3.1 |
|------------------------|------------------------|------------------------|------------------------|
| 5.56 (Armorer Install) | 5.56 (Armorer Install) | 5.56 (Armorer Install) | 7.62 (Armorer Install) |
| Length: 8.0" | Length: 10.75" | Length: 13.5" | Length: 13.5" |
| Weight: 8.6 oz | Weight: 11.4 oz | Weight: 13.8 oz | Weight: 14.2 oz |
| 30210 | 30590 | 30325 | 30259 |

CONTROL ACCESSORIES



AVAILABLE SIZES AND COLORS

| | | | | | | | | |
|--------------------------------|------------------------------------|----------------------------------|------------------------------------|-------------------------------|-------------------------------|-------------------------------|-------------------------------|-------------------------------|
| 11 Rib Panel Black 95047 | 11 Rib Panel Green 95047-GRN | 11 Rib Panel Tan 95047-TAN | 11 Rib Panel Taupe 95047-TAU | 9 Rib Panel Black 97169 | 6 Rib Panel Black 97168 | 5 Rib Panel Black 97167 | 4 Rib Panel Black 97166 | 2 Rib Panel Black 97164 |
|--------------------------------|------------------------------------|----------------------------------|------------------------------------|-------------------------------|-------------------------------|-------------------------------|-------------------------------|-------------------------------|

CONTROL ACCESSORIES



URX 3.1 PANEL KIT, LONG

The KAC URX 3.1 Long Rail Panel Kit contains a basic assortment of protective panels. Available in Black and Flat dark earth

30410-BLK

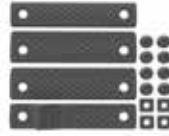

URX 3.1 PANEL KIT

The KAC URX 3.1 Long Rail Panel Kit contains a basic assortment of protective panels. Available in Black and Flat dark earth

30408-BLK



URX 3.1 DELUXE RAIL PANEL KIT

The KAC URX 3.1 Long Rail Panel Kit contains a basic assortment of protective panels. Available in Black and Flat dark earth

30409-BLK

SR-15/SR-25 COMPONENTS

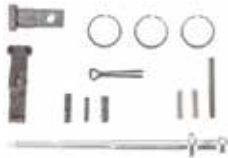

SR-15 FIELD REPAIR KIT

The SR-15 Field Repair Kit includes the essential components to keep your rifle running over the long term.

21318



SR-25 FIELD REPAIR KIT

The SR-25 Field Repair Kit includes the essential components to keep your rifle running over the long term.

98076-1



SR-25 MAGAZINE 20 AND 10 ROUND

KAC factory 20 and 10 Round Magazine for the SR-25/M110. Constructed of heat-treated steel.

98036-1



7.62 SUPPRESSORS



| 7.62 QDC/CQB SUPPRESSOR | 7.62 DSR/CQB | 7.62 CRS/QDC | 7.62 PRS /QDC | M110 SUPPRESSOR |
|--|---|--|--|---|
| Available in Black & FDE Length: 5.52" Weight: 13.02 oz 30179 | Available in Black & FDE Length: 5.75" Weight: 15 oz 32326 | Available in Black & FDE Length: 6.52" Weight: 15.8 oz 111671 | Available in Black & FDE Length: 9.24" Weight: 20.8 oz 111672 | Available in FDE Length: 14" Weight: 32 oz 24611 |

5.56 SUPPRESSORS



| 5.56 MM QDSS NT4 KIT | 5.56 QDC SUPPRESSOR | 5.56 QDC/CQB SUPPRESSOR |
|--|--|--|
| Available in Black Length: 6.5" Weight: 22 oz 96062-1 | Available in Black and Flat Dark Earth Length: 6.5" Weight: 16.7 oz 30123 | Available in Black and Flat Dark Earth Length: 5" Weight: 13.2 oz 30192 |

SIGHTING ACCESSORIES



FOLDING MICRO FRONT SIGHT

Our Folding Micro Front Sight is no exception and features a tool-free, finger-adjustable front sight post that makes performing sight corrections extremely fast and simple.

25654



FOLDING MICRO REAR SIGHT 300 METER

More economical than the adjustable 200-600 Meter Micro Rear Sight, the fixed post aperture of the 300 Meter Micro Rear Sight is ideal for shooters who want an easy to use, close to medium range back-up sighting solution.

25475



FOLDING MICRO REAR SIGHT 200-600

Our highly versatile 200-600 Meter Micro Rear Sight features a finger-adjustable, rotating drum that enables shooters to engage targets from 200 to 600 meters with both speed and accuracy.

25650



FOLDING REAR SIGHT 300 METER

Our simple and rugged 300 Meter Folding Rear Sight is more economical than the adjustable 200-600 Meter Rear Sight, and features a fixed post aperture that is ideal for shooters who want an easy to use, close to medium range back-up sighting solution.

97082



M4 FRONT SIGHT

Originally designed for the US military's SOPMOD rifle enhancement program, the KAC M4 Folding Front Sight is a low-profile backup sighting solution that is designed to be attached to the top rail of a rifle's handguard.

99051-BLK



FOLDING REAR SIGHT 200-600

The highly versatile 200-600 Meter Folding Rear Sight features a finger-adjustable, rotating drum that enables shooters to engage targets from 200 to 600 meters with both speed and accuracy.

98474



Fox Knives Bastinelli Black Bird

The Fox Black Bird is a compact Kerambit, designed by the French custom knife maker Bastinelli. The contoured black G10 handle scales provide excellent ergonomics, and the convertible clip (Tip-up/l-r) allows the desired carrying method. The locking is done by linerlock, the black coated blade is made of N690.

| | |
|-------------------------|--------------|
| Marke: | Fox Knives |
| Artikeltyp: | Pocket Knife |
| Designer: | Bastinelli |
| Total Length: | 6,7 |
| Blade Length: | 2.6 in |
| Blade Thickness: | 0.10 in |
| Weight: | 3.9 oz |
| Blade Material: | N690 |
| Handle Material: | G10 |
| Lock: | Linerlock |
| Opening: | Manual |



BÖKER
MANUFAKTUR SOLINGEN

LANCER



MAGAZINES

L5 ADVANCED WARFIGHTER MAGAZINE

Lancer set out to design a better 5.56 magazine and 300 Blackout; one with the reliability of steel, durability of polymer and weight of aluminum – the L5AWM. The magazine design includes a one-piece, wrap-around steel feed lip assembly and an aggressive surface texture to create the ultimate hybrid magazine tough enough for military and LE.

999-000-2320-01



| CALIBER | WEIGHT | DIMENSIONS | CAPACITY |
|--------------|---------|-----------------------|----------|
| 5.56 x 45 mm | 4.48 oz | 1.02 x 2.84 x 7.32 in | 30-round |
| 300 Blackout | 4.48 oz | 1 x 4 x 8 in | 30-round |

L7 ADVANCED WARFIGHTER MAGAZINE

The L7AWM is a lightweight magazine with an integrated front guard and welded steel feed lip which provides maximum stiffness and reliability while preventing dimpling to the front of the magazine. A switchable drain in the floor plate lock comes standard on all L7s, allowing users to configure the magazine for either water-borne or extreme dust conditions. Available now in 5, 10, 20 and 25-round capacities in translucent and opaque.

L7-10-BLK



| CALIBER | WEIGHT | DIMENSIONS | CAPACITY |
|------------------------|---------|-----------------------|----------|
| 7.62 x 51 mm / 308 Win | 7.84 oz | 1.33 x 3.39 x 8 in | 10-round |
| 7.62 x 51 mm / 308 Win | 6.4 oz | 1.32 x 3.39 x 6.35 in | 20-round |
| 7.62 x 51 mm / 308 Win | 5.6 oz | 1.32 x 3.39 x 4.24 in | 25-round |



.308/7.62 DRAGON

MUZZLE BRAKE 5/8-24 THREAD

Manufactured to the highest quality standards and featuring a patent pending design, the LANTAC DGN762B Muzzle Brake offers improved recoil management and muzzle rise over competitors products.

DGN762B



FEATURES

- Caliber: 7.62 mm / .308
- Material: Hardened Milspec Steel
- Finish: Phosphate, Type M, Class2
- Dimensions: L: 2.66", DIA Body: 0.866" DIA Fins: 0.900"
- Weight: 2.8 oz
- Thread: 5/8-24 UNEF R/H

.223/556 DRAGON

MUZZLE BRAKE 1/2-28 THREAD

Manufactured to the highest quality standards and featuring a patent pending design, the LANTAC DGN556B Muzzle Brake offers improved recoil management and muzzle rise over competitors products. Ultra Fast Attenuation of muzzle blast gasses means that Flash Signature is also reduced.

DGN556B



FEATURES

- Caliber: 5.56X45 mm / .223
- Material: Hardened Milspec Steel
- Finish: Nitride
- Dimensions: L: 2.570", DIA Body: 0.866"
- Weight: 3.2 oz
- Thread: 1/2-28 UNEF R/H

9 MM DRAGON

MUZZLE BRAKE 1/2-36 THREAD

Its unique Short Energy Pulse system reduces length of recoil so that repeating shot energy cannot overlap and knock the shooter off target. Full auto fire is possible with massively reduced recoil and muzzle climb, meaning that all shots fall on target.

DGN9MMB



FEATURES

- Caliber: 9 X 19 mm
- Material: Hardened Milspec Steel
- Finish: Phosphate, Type M, Class2
- Dimensions: L: 2.66", DIA Body: 0.866", DIA Fins: 0.900"
- Weight: 2.8 oz
- Thread: 1/2-36 UNEF R/H

LaserMax
PRECISION. PROTECTION.™



LASERS AND LIGHTS



MICRO II RAIL MOUNTED LASER

With a reinforced housing, convenient Quick Change Battery Hatch and advanced programming, the newest generation of the popular Micro laser system is now better than ever.

MICRO-2-R



GUIDE RODS LASER FOR GLOCK 17

Designed specifically for use in Glock 17 (Gen 4) and Glock 34 (Gen 4) pistols, the LMS-G4-17G replaces Glock's factory spring guide assembly with a high intensity green laser sighting system for advanced target acquisition.

LMS-G4-17G



GUIDE RODS LASER FOR GLOCK

Designed specifically for use in Glock 17, 22, 31, and 37 pistols, the LMS-1141P replaces Glock's factory spring guide assembly with a high intensity red laser sighting system for advanced target acquisition.

LMS-1141P



SPARTAN

Featuring the latest in LaserMax's SpartanT series it's the new Spartan Light & Laser, which installs in the preferred rail location for each operator's personal comfort and ease of use. Once anchored, Spartan maintains precision accuracy over extensive live fire.

SP5-C-G



1/3 N LITHIUM BATTERIES

Optimize the performance of your LaserMax CenterFire or UNI system by installing a fresh set of batteries at least once a year. Reliable, lightweight and powerful, 1/3 N Lithium batteries operate flawlessly across a wide range of temperatures and feature a full 10-year shelf-life.

LMS-2X13NC



PRO 700L FOLDING STOCK

REMINGTON 700L LONG ACTION

The Pro 700L combines innovative engineering, precision machining, Mil-Spec quality finishes, and an extensive list of purposeful design features with complete adjustability to provide demanding end users with the most comprehensive available precision rifle platform solution for true out of the box performance.

MAG1002-BLK



FEATURES

- Overall LOP adj. range is 13.25" - 15.125"
- Weight: 5.6 lbs
- Height at butt plate: 5.2"
- Max width: 1.86"
- Length: 33.5" - 35.4" (24.27" when folded)

PRO 700S FOLDING STOCK

REMINGTON 700 SHORT ACTION

The Pro 700 combines innovative engineering, precision machining, Mil-Spec quality finishes, and an extensive list of purposeful design features with complete adjustability to provide demanding end users with the most comprehensive available precision rifle platform solution for true out of the box performance.

MAG802-BLK



FEATURES

- Overall LOP adj. range is 13.25" - 15.125"
- Weight: 5.4 lbs
- Height at butt plate: 5.2"
- Max width: 1.86"
- Length: 32.7" - 34.6" (23.5" when folded)

PRO 700L FIXED STOCK

REMINGTON 700 LONG ACTION

The Pro 700L combines innovative engineering, precision machining, Mil-Spec quality finishes, and an extensive list of purposeful design features with complete adjustability to provide demanding end users with the most comprehensive available precision rifle platform solution for true out of the box performance.

MAG1003-BLK



FEATURES

- Overall LOP adj. range is 13.25" - 15.125"
- Weight: 5.6 lbs
- Height at butt plate: 5.2"
- Max width: 1.86"
- Weight: 2.8 oz
- Length: 33.5" - 35.4" (24.27" when folded)

MAGAZINES



PMAG 40 AR/M4 Gen M3 • Caliber: 5.56x45 mm NATO / .223 Rem • 40-round

MAG233-BLK-5



PMAG 30 AR/M4 Gen M2 MOE • Caliber: 223 Rem / 5.56x45 mm NATO • 30-round

MAG571-BLK



PMAG 20 LR/SR Gen M3 • Caliber: 7.62x51 mm NATO / 308 Winchester • 20-round

MAG291-BLK



PMAG 30 AR/M4 Gen M3 window • Caliber: 5.56x45 mm NATO / .223 Rem • 30-round

MAG556-BLK



PMAG 30 AR/M4 Gen M3 • Caliber: 5.56x45 mm NATO / .223 Rem • 30-round

MAG557-BLK



PMAG 20 AR/M4 GEN M3 • Caliber: 5.56x45 mm NATO / .223 Rem • 20-round

MAG560-BLK



PMAG 30 AR/M4 Gen M2 MOE window • Caliber: 5.56x45 mm NATO / .223 Rem • 30-round

MAG570-BLK



PMAG 30 AR 300 Gen M3 is a purpose designed magazine for rifles chambered in 300 Blackout • 30-round

MAG800-BLK



PMAG 10 GL9 • 9x19 Glock G17 • 10-round

MAG801-BLK



PMAG 10 LR/SR

The PMAG 10 LR/SR Gen M3 brings Gen M3 technology to the smallest possible magazine size. Perfect for hunting applications, depending on local hunting laws, and also for states where overall capacity is limited. The 10-round Gen M3 includes all of the benefits of the Gen M3 line. Perfect for use with a bipod or when shooting off of a pack.

PMAG 10 LR/SR Gen M3 • Caliber: 7.62x51 mm NATO / 308 Winchester

MAG290-BLK

MAGAZINE ACCESSORIES



When installed on the base of a 5.56x45 mm rifle magazine, the original Magpul provides improved speed and controllability during high stress.

MAG001-BLK



The Magpul rubberized loop attaches to the bottom of the magazine to increase controllability and speed during high-stress.

MAG002-BLK



When installed on the base of a submachine-gun magazine, the original Magpul provides improved speed and controllability.

MAG003-BLK



MagLink Magazine Coupler • PMAG 30 Gen M2 MOE/Gen M3

MAG595-BLK



The Magpul L-Plate is a floorplate replacement for current issue aluminum USGI 30-round magazines that incorporates a rubberized pad.

MAG024-BLK



The Magpul PMAG ranger plate is a floorplate replacement for the 5.56x45 mm PMAG AR/M4 Gen M3

MAG561-BLK



The Magpul enhanced self-leveling follower is a drop in replacement for the aluminum USGI 30-round magazine black or green follower.

MAG110-FOL



PMAG floor plate • Caliber: 7.62x39 mm • AK/AKM • 5 pack

MAG567-BLK



GL enhanced magazine well • Glock 17-19 Gen 3-4

MAG908-BLK

HANDGUARDS



MOE M-LOK handguard • Carbine-length AR-15/m4 • Weight: 6.8 oz • Length: 7.1" • Width: 2.2"

MAG424-BLK



MOE M-LOK forend • Remington 870 • M-LOK slots for direct attachment of accessories • Reinforced polymer constructions.

MAG496-BLK



MOE SL handguard • Carbine-length • AR15/M4 • Weight: 6.7 oz • Length: 8.9" • Width: 1.8" • Height: 2.4"

MAG538-BLK

STOCKS



MOE SL carbine stock • Tube type: Mil-Spec • Weight: 9.6 oz • Length of pull: 11.1" - 14.4"
MAG347-BLK



ACS carbine stock Mil-Spec • Width, max: 2.58 in • Weight: 14 oz • Length, max: 7.95 in • LOP Adj range: 3.25 in • LOP, M4 Collapsed: 11.75 in
MAG370-BLK



The MOE stock Mil-Spec model is a drop-in replacement buttstock for AR15/M16 carbines using mil-spec sized receiver extension tubes.
MAG400-BLK



STR carbine stock - Mil-spec model • Weight, w/ Rec. extension: 1.02 lbs • Weight: 0.77 lbs • Length, maximum: 7.30 in • Width, maximum: 2.58 in
MAG470-BLK



The Magpul CTR Mil-Spec Model is a drop-in replacement buttstock for AR15/M16 carbines using mil-spec sized receiver extension tubes.
MAG310-BLK



MOE SL-K carbine stock • Weight: 7.9 oz • Weight, w/receiver extension: 11.9 oz • Length, max: 6.5 in • Height, max: 4.2 in
MAG626-BLK



PRS Gen 3 precision - adjustable stock • Weight: 15 oz • Weight, w/rifle receiver extension: 28.5 oz • Length, maximum: 11.5-12.9 in
MAG672-BLK



SGA stock Mossberg 500/590/590A1 • Weight: 1.5 lbs • LOP adjustment range: 12.3-14.3 in
MAG490-BLK



SGA stock Remington 870 • Weight: 1.5 lbs • Spacer-adjustable LOP in 1/2" increments from 12.5" to 14.5" • Recoil reducing butt-pad
MAG460-BLK

STOCKS ACCESSORIES



CTR/MOE 0.25" cheek riser • Clip on cheek riser for the MOE and CTR stocks • Raises cheek weld 1/4 inch in height
MAG325-BLK



CTR/MOE 0.50" cheek riser • Clip on cheek riser for the MOE and CTR stocks • Raises cheek weld 1/2 inch in height
MAG326-BLK



CTR/MOE 0.75" cheek riser • Clip on cheek riser for the MOE and CTR stocks • Raises cheek weld 3/4 inch in height
MAG327-BLK

FIREARMS PARTS & ACCESSORIES



The Magpul Enhanced Rubber Butt-Pad, 0.70" is an optional replacement butt pad for the CTR and MOE Mil-Spec stocks as well as all STR, ACS-L, ACS and UBR stocks.

MAG317-BLK



The Magpul Bipod offers serious strength and versatility at a price that provides unmatched value • For 1913 rail

MAG941-BLK



The Magpul Bipod offers serious strength and versatility at a price that provides unmatched value • For M-LOK

MAG933-BLK



The Magpul enhanced trigger guard is a drop-in aluminum replacement for AR15/M4 trigger guards, designed to provide increased clearance for use with gloves.

MAG015-BLK



The MOE Trigger Guard is an economical, drop-in polymer replacement for AR15/M4 trigger guards, designed to provide increased clearance for use with gloves, and to eliminate the annoying gap at the rear of the mil-spec trigger guard.

MAG417-BLK



The Magpul AR Enhanced Magazine Release provides an enlarged contact surface for quick and fumble free magazine changes.

MAG568-BLK



The M-LOK QD Sling Mount provides a forward attachment point for the Magpul MS4 Sling and other push-button QD slings.

MAG606-BLK



The Magpul Dynamics Precision Rifle Data Book uses a simplified density altitude-based, color-coded chart to record your rifles data across a wide spectrum of shooting conditions.

DYN036



The Magpul Dynamics Precision Rifle Quick Reference Cards offer the shooter a comprehensive overview of the fundamentals of marksmanship, quick reference range estimation sheets.

DYN037

GRIPS AND ACCESSORIES



MOE+ grip • Weight: 3.4 oz • Texture: Vertical grip angle • Height: 4.0" • Thickness: 1.2"
MAG416-BLK



MOE grip - AR15/M4 • Thickness: 1.2 in • Weight, w/hardware: 2.8 oz • Height: 4.0 in
MAG415-BLK



MOE-K2+ grip - AR15/M4 • Thickness: 1.2 in • Weight 3.1 oz • Height: 4.1 in
MAG532-BLK



RVG • Rail vertical grip • For 1913 Picatinny railed handguards
MAG412-BLK



The M-LOK MVG is a light weight, inexpensive vertical foregrip that attaches directly to M-LOK.
MAG597-BLK



MOE-K grip - AR15/M4 • Weight, w/ hardware: 2.4 oz • Height: 3.8 in • Thickness: 1.0 in
MAG438-BLK



MOE-K2 grip - AR15/M4 • Weight, w/ hardware: 2.9 oz • Height: 4.1 in • Thickness: 1.2 in
MAG522-BLK



Compatible with most any M1913 Picatinny-railed handguard, the Magpul AFG takes into account natural body mechanics and provides a comfortable and stable user interface.
MAG411-BLK



The AFG-2 is a slim line design that is shorter in overall length and width compared to the original AFG.
MAG414-BLK



The MIAD (Mission Adaptable) Gen 1.1 Grip is a drop-in replacement for the standard AR15/AR10 grip, now available in two dedicated configurations to fit most receivers.
MAG520-BLK



The Magpul M-LOK AFG (Angled Fore Grip) is the result of research and refinements done to the original AFG and AFG-2.
MAG598-BLK



Internal core unit for the MIAD as well as the MOE, MOE-K2, and MOE AK Grips designed to hold two CR123A lithium type batteries in a self contained, water resistant unit.
MAG055-BLK

SIGHTS



MBUS sight front, Gen 2 • Weight: 1.2 oz • Height above rail, stowed: ~0.51" • Length, stowed: 2.6" • Length, deployed: 1.5"

MAG247-BLK



MBUS sight rear Gen 2 • Weight, w/ hardware: 1.3 oz • Center of aperture to top of rail: 1.42" • Length, stowed: 2.6" • Length, deployed: 1.5"

MAG248-BLK



MBUS pro sight front • Weight, w/ hardware: 1.5 oz • Height above rail, stowed: ~0.43" max • Length, stowed: 1.6"

MAG275-BLK



MBUS pro offset front • Weight, w/ hardware: 2.0 oz • Height above rail at clamp: ~0.18" • Length, stowed: 2.0" • Small aperture dia: 0.07" • Large aperture dia: 0.19"

MAG525-BLK



MBUS pro offset sight rear • MBUS pro offset front • Weight, w/ hardware: 1.8 oz • Height above rail at clamp: ~0.18" • Length, stowed: 1.9"

MAG526-BLK



MBUS pro LR adjustable sight rear • Weight, w/ hardware: 2.0 oz • Height above rail, stowed: ~0.49" max • Small aperture dia: 0.07" • Length, stowed: 2.2" • Large aperture dia: 0.19"

MAG527-BLK

RAILS AND COVER ACCESSORIES



The Rail Light Mount fits on any standard 1913 Picatinny Rail, is available in Right or Left side models.

MAG498-LT-BLK



M-LOK offset light/optic mount aluminum • Mil-Spec anodized aluminum • Diameter from 0.75" to 1.03"

MAG604-BLK



M-LOK polymer offset light mount • Diameter from 0.75" to 1.03" • Positions light or optics at either the 11 or 1 o'clock positions

MAG605-BLK

FIREARM MAINTENANCES



The patent-pending Speedthreader is designed to dramatically improve the speed and ease of configuring MOLLE/PALS webbing.

MAG220-BLK



American-made, solid steel construction with grip-enhancing phosphite finish engages both stock and pin-style barrel nuts.

MAG535-BLK



The BEV Block (Barrel Extension Vise) is an all-in-one, compact vise block tool for AR15/M4 assembly operations of barrel nuts, flash hiders, etc.

MAG536-BLK

RAILS AND COVER ACCESSORIES



XTM enhanced rail panels • Texture is aggressive anti-slip two-piece covers and fits on any standard 1913 Picatinny rail • Each set comes with four (4) two-piece panels which will cover one side of a carbine rail.

MAG510-GRY



M-LOK aluminum rail • 3 slots • Designed for use with all M-LOK compatible Hand Guards and Forends, M-LOK Aluminum Rail Sections allow the attachment of various 1913 Picatinny spec rail-mounted accessories such as lights, etc.

MAG580-BLK



Designed for use with all M-LOK compatible Hand Guards and Forends, M-LOK Polymer Rail Sections provide a cost effective method of attaching various 1913 Picatinny spec rail-mounted accessories such as lights, vertical grips, etc.

MAG589-BLK



Light mount v-block & rings is a nearly-universal mounting solution for attaching a handheld light to compatible Magpul light mounts

MAG614-BLK



M-LOK tape switch mounting plate. Providing light weight with extremely rugged construction. To attach Surefire ST pressure pads on M-LOK compatible systems

MAG617-BLK



M-LOK hand stop kit • Light weight, low-profile M-LOK slot index point for improved weapon control • Aggressive TSP Texture for enhanced weapons control.

MAG608-BLK



M-LOK Cantilever rail / light mount Polymer, M-LOK System

MAG587-BLK



M-LOK cantilever rail/light mount • Polymer • Picatinny slots that extend forward .75"-1.5" • Length: 3.15" • Slots: 3

MAG603-GRY



xtm hand stop kit • Includes one hand stop, one index panel, one full xtm enhanced panel and one xtm enhanced half panel.

MAG511-BLK



M-LOK afg-2 rail adapter • Length: 4.7" • Slots: 3

MAG594-BLK



RVG M-LOK adapter rail • Length: 1.9" • Slots: 2

MAG596-BLK

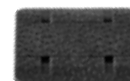

M-LOK rail cover type 2 • Texture: TSP Two-piece covers that install directly onto most M-LOK aluminum handguards • Length: 9.5"

MAG603-BLK

RAILS AND COVER ACCESSORIES



XT rail panel 1913 Picatinny • Length: 12" • Width: 2" • Height: 0.4" • Weight: 1.6 oz

MAG012-BLK



Ladder rail panel 1913 Picatinny • Length: 12" • Width: 2" • Height: 0.4" • Weight: 1.6 oz

MAG013-BLK



MOE polymer rail, MOE slot • Mounting screw center-to-center of 3.2" • Length 4.9"

MAG406-BLK

SLINGS AND ACCESSORIES



The MS1 Sling is the most versatile addition to the Magpul line of rifle slings. This sling system starts as an optimized, dedicated two-point sling that serves equally well in a one-point role when using optional adapters.

MAG513-BLK



ms3 Gen 2 slings • Width, webbing 1.25" • Fast transition between a single-point sling and two-point sling.

MAG514-BLK



Filling the same mission requirement as the standard MS3 Sling, the MS3 Single QD can quickly switch between one-point and two-point configuration.

MAG515-BLK



The MS4 Sling is a Dual-QD version of the standard MS3 Sling. With Push-Button QD Sling Swivels in place of the standard Paraclips, and now with the MS1 slider.

MAG518-BLK



The MS1 Padded Sling is an optimized, dedicated two-point sling that serves equally well in a one-point role when using optional adapters.

MAG545-BLK



Building on the heritage and proven performance of Magpul's MS sling series, the Magpul RLS (rifleman loop sling) is a durable, lightweight, and affordable shooting aid and retention device.

MAG1004-BLK

SLINGS & SLING ATTACHMENTS



ASAP QD ambidextrous sling attachment point • Works with both Mil-Spec and commercial-spec carbine receiver extensions (buffer tubes).

MAG529-BLK



The QD Paraclip Adapter fits push-button QD swivel sockets to allow use with Paraclips and other clip-in sling attachments.

MAG542-BLK



QDM quick disconnect sling swivel • Weight: 0.7 oz • Width, webbing: 1.25" • Compatible with all standard sized QD cups.

MAG543-BLK



RSA rail sling attachment • Works on any MIL-STD-1913 Picatinny/stanag 4694 rail • Has been proven to withstand stress tests of over 300 pounds while only weighing a mere 1.3 oz

MAG502-BLK



RSA QD rail sling attachment • Compatible with Magpul MS4 sling and other push-button QD slings.

MAG337-BLK



MS1, MS3 adapter • Combine with MS1 sling and Paraclip to provide 2-1 point construction • Width, webbing: 1.25"

MAG516-BLK



Forward sling mount • Dedicated fit for the Mossberg 500, 590, and Maverick shotguns with an extended mag tube.

MAG508-BLK



QD sling swivel • Width, webbing: 1.25" • Push-button quick-detach sling swivel for 1.25" webbing • Manganese-phosphate finished steel.

MAG540-BLK



Paraclip • Clip-style sling attachment point for 1.25" webbing • Melonite finished steel and reinforced polymer construction • Width: 1.25"

MAG541-BLK



ASAP ambidextrous sling attachment point • Works with both Mil-Spec and commercial-spec carbine receiver extensions.

MAG500-BLK



SGA receiver sling mount • For the SGA shotgun stock and one-point clip-in style attachments such as the MS3 Paraclip, the HK hook, ITW MASH hook, and others.

MAG507-BLK



M-LOK Paraclip sling mount is a steel clip-in sling mount for M-LOK extremely durable Melonite finish.

MAG607-BLK

EYEWEARS



SUMMIT EYEWEAR

Designed for our most demanding customers, the Summit provides premium ballistic and safety rated protection in a smaller frame than the Terrain. Its TR90NZZ frames and polycarbonate lenses combine to create the same extreme impact resistance and versatility as the Terrain, but with a smaller fit and coverage.

MAG1022-061



EXPLORER EYEWEAR

The Explorer is a casual design that incorporates high performance features for those times when you want both protection and style in your life. With the same lens and frame construction and materials as the Terrain and the Summit, the Explorer provides extreme impact resistance, durability, and flexibility in a more lightweight package you can wear everywhere.

MAG1024-061

FRAME COLOR OPTIONS



LENS COLOR OPTIONS



TERRAIN EYEWEAR

The Terrain is designed for our most demanding customers, and it's well suited for those who require ballistic and safety protection for maximum coverage in a larger frame.

MAG1020-061



MAGPUL EXPLORER XL

The Explorer XL's thicker frame, sculpted lines, and defined corners give it an edgier, more pronounced style than the standard Explorer, and its fit is optimized for medium and large faces.

MAG1046-061



MAGPUL RADIUS

The Radius is specifically designed for maximum comfort, coverage, ballistic protection and style. Designed with the shooter in mind, the frames provide full Z87+ ballistic protection, durability, and flexibility in a lightweight package.

MAG1042-061

MILITARY ST

M-LOK M-LOK ACCESSORIES

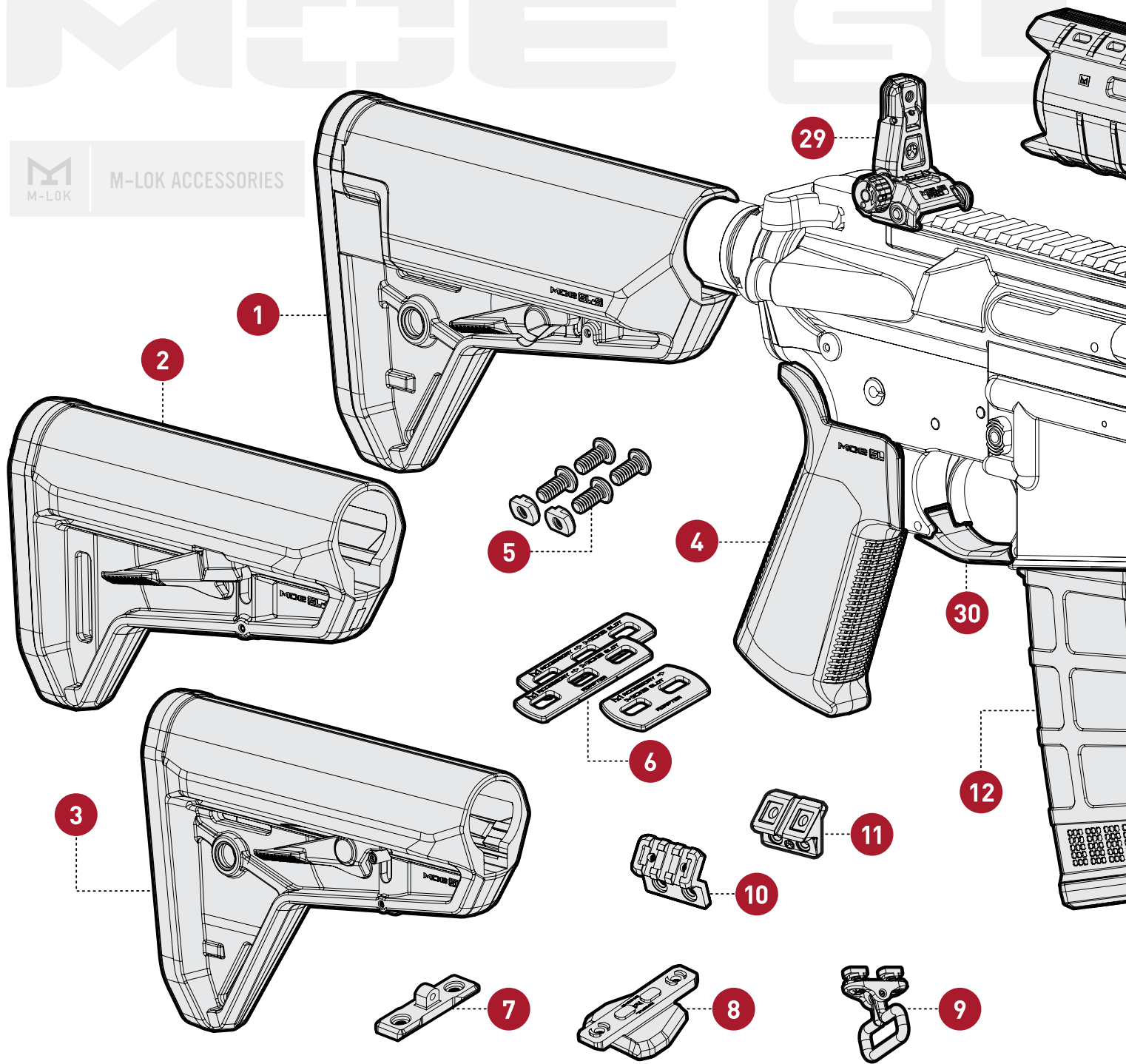

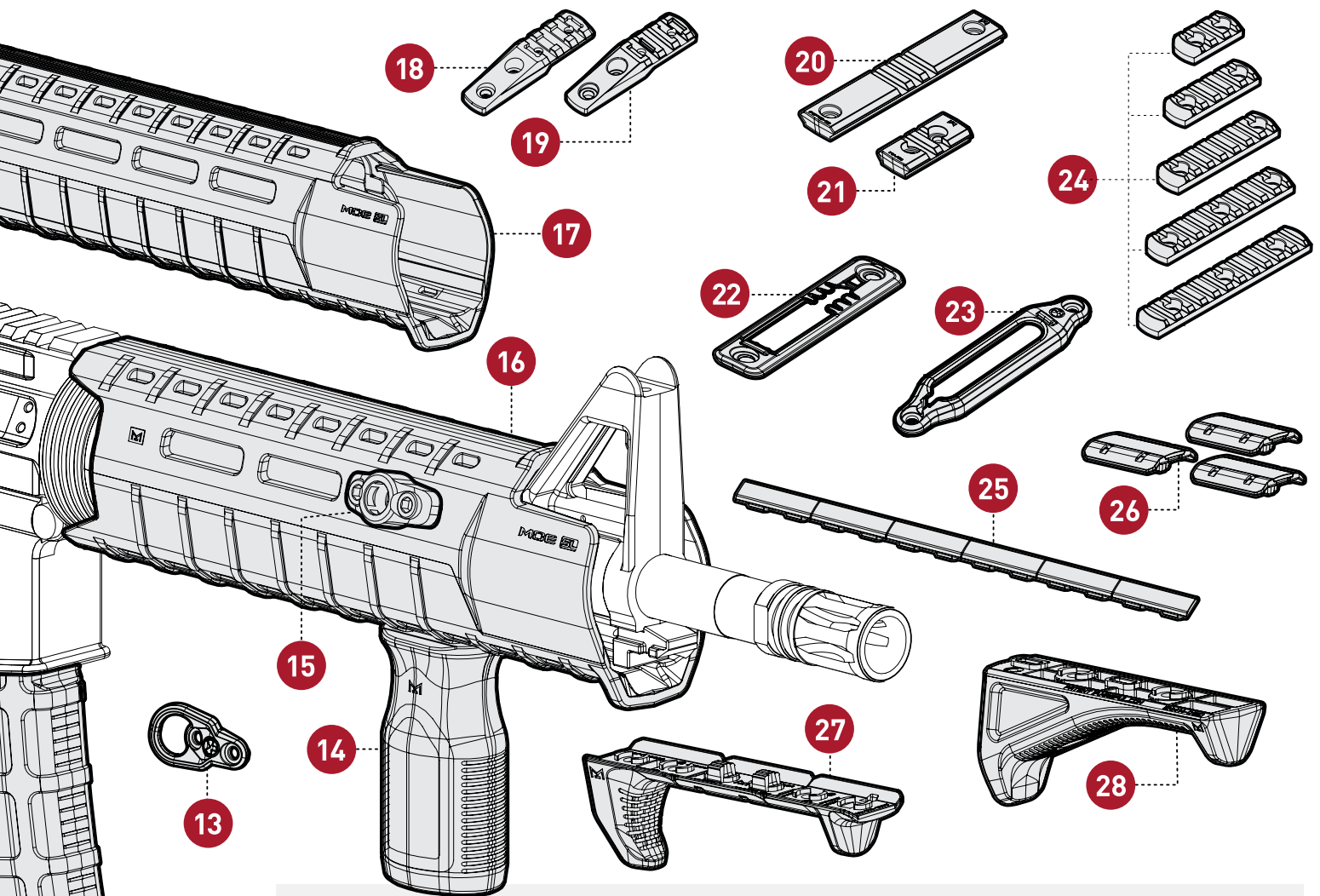

- | | | | | | |
|----|--|------------|----|---|-------------|
| 1 | MOE SL-S Stock | MAG347/348 | 16 | MOE SL Hand Guard, Carbine | MAG538 |
| 2 | MOE SL-K Stock | MAG626 | 17 | MOE SL Hand Guard, Mid | MAG551 |
| 3 | MOE SL Stock | MAG653 | 18 | M-LOK Cantilever Rail/Light Mount, Polymer | MAG587 |
| 4 | MOE SL Grip | MAG539 | 19 | M-LOK Cantilever Rail/Light Mount, Aluminum | MAG588 |
| 5 | T-NUT Replacement Set | MAG615 | 20 | AFG-2 M-LOK Adapter Rail | MAG594 |
| 6 | MOE to M-LOK Adapter | MAG478 | 21 | RVG M-LOK Adapter Rail | MAG596 |
| 7 | M-LOK Bipod Mount | MAG609 | 22 | M-LOK Tape Switch Mounting Plate, Surefire ST | MAG617 |
| 8 | M-LOK Tripod Adapter | MAG624 | 23 | M-LOK Tape Switch Mounting Plate, Insight PEQ | MAG596 |
| 9 | M-LOK GI Sling Swivel | MAG809 | 24 | M-LOK Rails, Polymer and Aluminum | see website |
| 10 | M-LOK Offset Light/Optic Mount, Aluminum | MAG604 | 25 | M-LOK Rail Cover, Type 1 | MAG602 |
| 11 | M-LOK Offset Light/Optic Mount, Polymer | MAG605 | 26 | M-LOK Rail Cover, Type 2 | MAG603 |
| 12 | PMAG 30 GEN M3 | MAG557 | 27 | M-LOK Hand Stop Kit | MAG608 |
| 13 | M-LOK Paraclip Sling Mount | MAG607 | 28 | M-LOK AFG - Angled Fore Grip | MAG598 |
| 14 | M-LOK MVG Vertical Grip | MAG597 | 29 | MBUS Pro Rear | MAG276 |
| 15 | M-LOK QD Sling Mount | MAG606 | 30 | MOE Trigger Guard | MAG417 |

MAGAZINE COMPARISONS

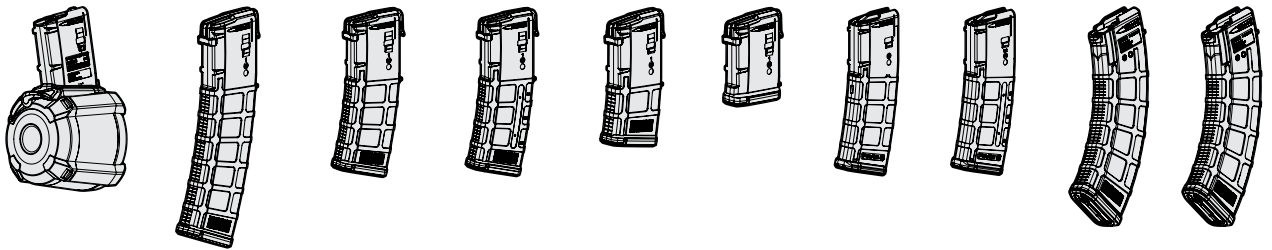

| | PMAG D-60 | PMAG 40 AR/M4 GEN M3 | PMAG 30 AR/M4 GEN M3 | PMAG 30 AR/M4 GEN M3 W | PMAG 20 AR/M4 GEN M3 | PMAG 10 AR/M4 GEN M3 | MOE PMAG 30 AR/M4 GEN M2 | MOE PMAG 30 AR/M4 GEN M2 W | PMAG 30 AK/AKM GEN M3 | MOE PMAG 30 AK/AKM | | |
|--------------|---------------------------------------|---------------------------------------|---------------------------------------|---------------------------------------|---------------------------------------|---------------------------------------|---------------------------------------|-------------------------------|--------------------------|-----------------------|--------|--|
| SKU | MAG576 | MAG233 | MAG557 | MAG556 | MAG560 | MAG559 | MAG571 | MAG570 | MAG573 | MAG572 | | |
| MSRP | \$129.95 | \$19.95 | \$14.95 | \$17.95 | \$13.95 | \$13.95 | \$12.95 | \$15.95 | \$26.95 | \$13.95 | | |
| WEAPON | AR15 - M4 HK 416 SA80 - SCAR 16 | AR15 - M4 HK 416 SA80 - SCAR 16 | AR15 - M4 HK 416 SA80 - SCAR 16 | AR15 - M4 HK 416 SA80 - SCAR 16 | AR15 - M4 HK 416 SA80 - SCAR 16 | AR15 - M4 HK 416 SA80 - SCAR 16 | AR15 - M4 HK 416 SA80 - SCAR 16 | AR15 - M4 | AR15 - M4 | AK/AKM | AK/AKM | |
| CALIBER | 5.56/.223 | 5.56/.223 | 5.56/.223 | 5.56/.223 | 5.56/.223 | 5.56/.223 | 5.56/.223 | 5.56/.223 | 7.62X39 | 7.62X39 | | |
| ROUNDS | 60 | 40 | 30 | 30 | 20 | 10 | 30 | 30 | 30 | 30 | | |
| COLORS | BLK | BLK | BLK - MCT | BLK - MCT | BLK | BLK | BLK | BLK | BLK | BLK | | |
| GENERATION | M3 | M3 | M3 | M3 | M3 | M3 | M2 | M2 | M3 | M3 | | |
| MARKING GRID | ■ | ■ | ■ | ■ | ■ | | | | ■ | ■ | | |
| WINDOW | ■ | | | ■ | | | | ■ | | | | |

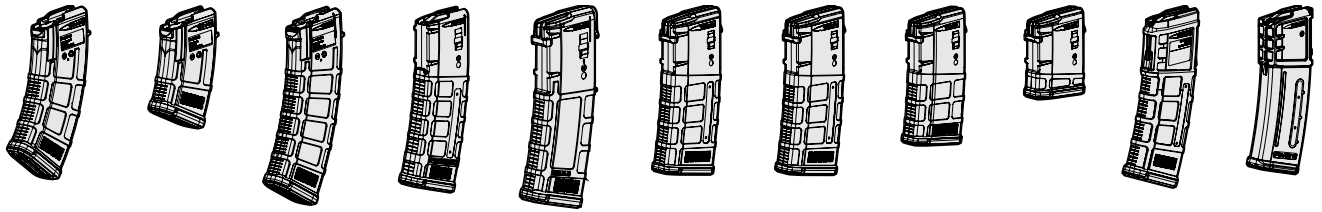

| | MOE PMAG 20 AK/AKM | MOE PMAG 10 AK/AKM | MOE PMAG 30 AK74 | PMAG 30 SPC GEN M3 W | PMAG 30 AR 300 B GEN M3 | PMAG 25 M118 LR/SR | PMAG 25 LR/SR GEN M3 | PMAG 20 LR/SR GEN M3 | PMAG 10 LR/SR GEN M3 | PMAG 30 AUS GEN M3 W | PMAG 30G |
|--|-----------------------|-----------------------|---------------------|-------------------------|----------------------------------|-----------------------|-------------------------|-------------------------|-------------------------|-------------------------|-----------|
| | MAG658 | MAG657 | MAG673 | MAG555 | MAG800 | MAG577 | MAG292 | MAG291 | MAG290 | MAG575 | MAG234 |
| | \$12.95 | \$12.95 | \$13.95 | \$19.95 | \$15.95 | \$22.95 | \$22.95 | \$19.95 | \$18.95 | \$19.95 | \$27.95 |
| | AK/AKM | AK/AKM | AK74 | LWRC SIX8 | AR15 - M4 SIG MCX (300BLK) | SR25 - M110 | SR25 - M110 | SR25 - M110 | SR25 - M110 | STEYR AUG/F88/F90 | HK G36 |
| | 7.62X39 | 7.62X39 | 5.45X39 | 6.8X43/6.8 SPC | 7.62X35/300BLK | 7.62X51/.308 | 7.62X51/.308 | 7.62X51/.308 | 7.62X51/.308 | 5.56/.223 | 5.56/.223 |
| | 20 | 10 | 30 | 30 | 30 | 25 | 25 | 20 | 10 | 30 | 30 |
| | BLK | BLK | BLK | BLK | BLK | BLK | BLK | BLK | BLK | BLK | BLK |
| | M3 | M3 | M3 | M3 | M3 | M3 | M3 | M3 | M3 | M3 | M2 |
| | ■ | ■ | ■ | ■ | ■ | ■ | ■ | ■ | | ■ | |
| | | | | ■ | | ■ | ■ | | | ■ | ■ |

STOCK COMPARISONS

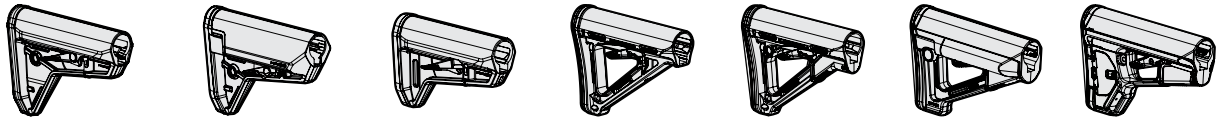

| | MOE SL CARBINE | MOE SL-S CARBINE | MOE SL-K CARBINE | MOE CARBINE | CTR CARBINE | STR CARBINE | ACS-L CARBINE | |
|-----------------------|---------------------------------|---------------------------------|---------------------------------|---|-------------------------------------|-------------------------------------|-------------------------------------|--|
| SKU | MAG347 MAG348 | MAG653 | MAG626 | MAG400 MAG401 | MAG310 MAG311 | MAG470 MAG471 | MAG378 MAG379 | |
| MSRP | \$59.95 \$59.95 | \$79.95 | \$39.95 | \$39.95 \$39.95 | \$59.95 \$59.95 | \$79.95 \$79.95 | \$79.95 \$79.95 | |
| TUBE TYPE | MIL SPEC COMMERCIAL | MIL SPEC | MIL SPEC | MIL SPEC COMMERCIAL | MIL SPEC COMMERCIAL | MIL SPEC COMMERCIAL | MIL SPEC COMMERCIAL | |
| WEIGHT | 9.6 OZ. 9.6 OZ. | 12 OZ. | 8 OZ. | 8.1 OZ. 8.5 OZ. | 8.8 OZ. 9.3 OZ. | 12.3 OZ. 12.3 OZ. | 12.5 OZ. 12.5 OZ. | |
| LENGTH OF PULL | 10.8" - 14.1" 10.8" - 14.9" | 10.9" - 14.2" | 10.3" - 13.6" | 10.5" - 13.8" 10.8" - 14.6" | 10.5" - 13.8" 10.8" - 14.6" | 10.9" - 14.2" 10.9" - 14.7" | 11.6" - 15.4" 10.9" - 14.7" | |
| COLOR | BLK - FDE - ODG - GRY | BLK - FDE - ODG - GRY | BLK - FDE - ODG - GRY | BLK - FDE - ODG - GRY - PNK MAG401 BLK | BLK - FDE - ODG - GRY MAG311 BLK | BLK - FDE - ODG - GRY MAG471 BLK | BLK - FDE - ODG - GRY MAG379 BLK | |
| COMPATIBILITY | AR15 - M4 - AR10 SR25 - M110 | AR15 - M4 - AR10 SR25 - M110 | AR15 - M4 - AR10 SR25 - M110 | AR15 - M4 - AR10 SR25 - M110 | AR15 - M4 - AR10 SR25 - M110 | AR15 - M4 - AR10 SR25 - M110 | AR15 - M4 - AR10 SR25 - M110 | |
| COLLAPSIBLE | ■ | ■ | ■ | ■ | ■ | ■ | ■ | |
| FRICTION LOCK | TUBE TENSION SYSTEM | TUBE TENSION SYSTEM | TUBE TENSION SYSTEM | | ■ | ■ | ■ | |
| CHANGEABLE BUTT-PAD | ■ | ■ | | ■ | ■ | ■ | ■ | |
| IMPROVED CHEEKWELD | ■ | ■ | ■ | | | ■ | ■ | |
| STORAGE | | ■ | | | | | ■ | |
| BATTERY STORAGE | | ■ | | | | ■ | | |
| ADJUSTABLE CHECKPIECE | | | | | | | | |
| SLING LOOP | ■ | ■ | ■ | ■ | ■ | ■ | ■ | |
| QD CUP MOUNT POINTS | ■ | ■ | | | ■ | ■ | ■ | |
| BOTTOM ACCESSORY RAIL | | | | | | | | |
| ASAP COMPATIBLE | ■ | ■ | ■ | ■ | ■ | ■ | ■ | |

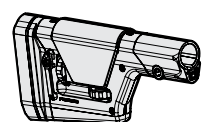
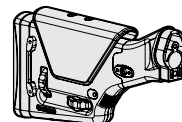
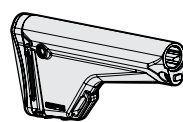
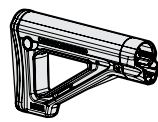
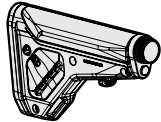
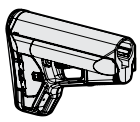

| | ACS CARBINE | UBR GEN2 | MOE FIXED CARBINE | MOE RIFLE | PRS2 | PRS GEN3 |
|--|-------------------------------------|---------------------------------|-------------------------------------|----------------------------------|----------------------------------|---------------------------------|
| | MAG370 MAG371 | MAG482 | MAG480 MAG481 | MAG404 | MAG341 MAG340 | MAG672 |
| | \$89.95 \$89.95 | \$199.95 | \$29.95 \$29.95 | \$69.95 | \$255.00 \$255.00 | \$254.95 |
| | MIL SPEC COMMERCIAL | PROPRIETARY LENGTH INCLUDED | MIL SPEC COMMERCIAL | RIFLE BUFFER TUBE | FN FAL HK G3/91 | MIL SPEC OR RIFLE BUFFER TUBE |
| | 14.0 OZ. 14.0 OZ. | 21.3 OZ. | 12.25 OZ. | 14.0 OZ. | 30.2 OZ. 30.9 OZ. | 27.8 OZ. |
| | 11.75" - 15.00" 11.75" - 15.55" | 11.75" - 15.25" | 12.375" 12.375" | 13.50" | 14.30" - 15.5" 15.00" - 16.20" | 14.30" - 15.7" |
| | BLK - FDE - ODG - GRY MAG371 BLK | BLK - FDE - ODG - GRY | BLK - FDE - ODG - GRY MAG481 BLK | BLK - FDE - ODG - GRY | BLK | BLK - FDE - ODG - GRY |
| | AR15 - M4 - AR10 SR25 - M110 | AR15 - M4 - AR10 SR25 - M110 | AR15 - M4 - AR10 SR25 - M110 | AR15 - M16 - AR10 SR25 - M110 | FAL (METRIC) HKG3/91 | AR15 - M4 - AR10 SR25 - M110 |
| | ■ | ■ | | | | ■ |
| | ■ | | | | | |
| | ■ | ■ | ■ | ■ | ■ | |
| | ■ | ■ | | ■ | ■ | ■ |
| | ■ | ■ | | ■ | | |
| | ■ | | | | ■ | ■ |
| | ■ | ■ | ■ | ■ | ■ | ■ |
| | ■ | ■ | AVAILABLE | AVAILABLE | ■ | ■ |
| | | | | AVAILABLE | | AVAILABLE |
| | ■ | | ■ | | | |



MANTIS



TRAINING SYSTEMS



MANTIS X10

The Mantis X10 is the next revolution of the breakthrough MantisX. Collecting thousands of data points per second, the X10 analyzes your shooting in real-time. For pistols, rifles, and shotguns. The X10 works with dry fire, live fire, airsoft/CO2, and simulated weapons systems.

Dimensions: 1.3" x 1" x 0.75" L x W x H

MT-1004



MANTISX

MantisX app, for use on your iOS and Android smartphone/tablet that supports Bluetooth 4.0.

MT-1001



MANTIS X3

The Mantis X3 is the next evolution of the breakthrough MantisX.

MT-1002



MANTIS X7

The Mantis X7 is the most powerful shotgun sports analyzer.

MT-1003



GLOCK 9 MM/.40

Replaces the standard Glock double stack magazine floor plate with a rail adapter.

MT-2002



SPRINGFIELD XD-9

Replace the Springfield XD-9 magazine base plate with a rail adapter.

MT-2011

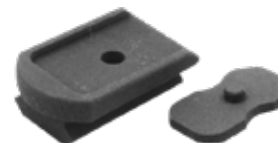

SIG SAUER P226

Replace the Sig Sauer P226 magazine base plate with a rail adapter.

MT-2008



WALTHER PPS M2 9 MM

Replaces the standard (6-round) Walther PPS M2 9 mm magazine floor plate with a rail adapter.

MT-2019



WALTHER PPQ M2 9 MM

Replaces the standard Walther PPQ M2 9 mm magazine floor plate with a rail adapter.

MT-2020



SIG SAUER P320

Replaces the standard Sig Sauer P320 or P250 magazine floor plate with a rail adapter.

MT-2021

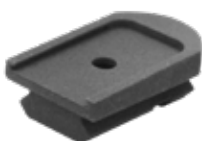

BERETTA M92FS/M9

Replaces the standard Beretta 92 magazine floor plate with a rail adapter.

MT-2026



1911 WILSON COMBAT 9 MM

Replace the Wilson Combat 47D 1911 magazine base plate with a rail adapter.

MT-2015



UNIVERSAL MAGRAIL

A Picatinny rail adapter that bonds to the bottom of your magazine floor plate.

MT-2001

 MEGGAR[®]



MAGAZINES



BERSA THUNDER

.380 ACP 8 high cap • Capacity 8 high cap • Increased capacity of 8-rounds • Carbon steel tube, heat-treated for strength • Polymer finger rest removable butt-plate • Nickel

MGBT3808N



1911

.45 ACP • 7 standard • Capacity 7 standard • Full-size government • Carbon steel tube, heat-treated for strength • Higher tensile music wire spring • Steel follower • Blue

MGCG4507B



BROWNING

.40 S&W • Capacity 10 standard • Compatibility: Browning hi power • Carbon steel tube, heat-treated for strength • Higher tensile music wire spring • Steel follower • Blue

MGBR4010B



CZ 75B, 85B, SP-01

Caliber .40 S&W • Capacity 10 limited • Carbon steel tube • Heat-treated for strength • Blue

MGCZ4010B



KIMBER TEN II

Caliber .45 • Capacity 10 limited • Carbon steel tube • Heat-treated for strength • Anti-friction

MGK4510AFC



RUGER MARK II

Caliber .22 LR • Capacity 10 standard • Carbon steel tube, heat-treated for strength • Higher tensile music wire spring • Blue

MGMK22LRB



SIG SAUER P.226

Caliber 9 mm • Capacity 10 limited • Carbon steel tube • Heat-treated for strength • Nickel

MGP22610N



ADAPTER

Plus-2 adapter base for Mec-Gar optimum series magazines only • Calibre/Gauge 9 mm • Black

F42099-SET

MAGAZINES FEATURE

COMPATIBLE COMPANIES

Beretta • Bersa • Browning • 1911 • CZ • Kimber • Luger • Para-USA • Ruger • Sig Sauer • Smith & Wesson • Springfield • Taurus • Witness • Walther

AVAILABLE CALIBERS

9 mm • .40 S&W • .380 ACP • .22 LR • .25 ACP • .380 ACP • .45 ACP • 10 mm • .38 SUPER • .38 SUP/9 mm • .40 S&W/.357 • .32 ACP

AVAILABLE FINISHES

Blue • Nickel • Phosphate • Anti-Friction • 17-7 S/S • AFC



**MESA
TACTICAL**

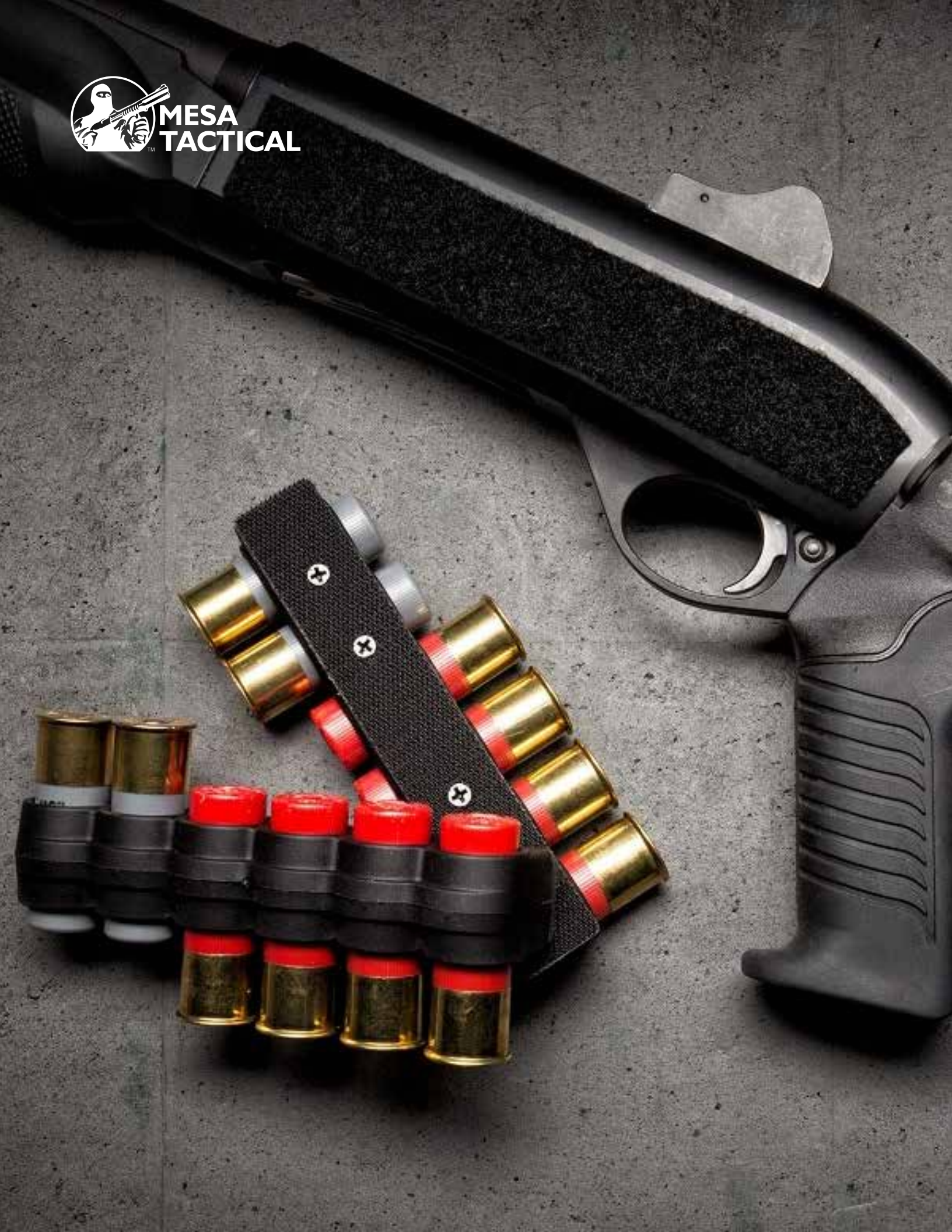

STOCKS & FORENDS



URBINO PISTOL GRIP STOCK

Mesa Tactical's Urbino pistol grip stock is a fixed-length pistol grip shotgun stock made from injection-molded glass-filled nylon.

90070



LEO GEN II TELESCOPING

Adapts AR-15 style buttstocks and pistol grips for use with Remington 870/V3, Mossberg 500/590 and Beretta 1301 shotguns.

Hydraulic recoil stock kit for Rem V3 • Stock adapters are investment cast aircraft grade aluminum

91260

FIREARM PARTS & STOCK ACCESSORIES



SURESHELL CARRIER 6-SHELL

Shell holder carriers are milled from 6061-T6 aircraft aluminum, then bead blasted and mil-spec.

90210



SURESHELL POLYMER CARRIER

SureShell Polymer Carriers are injection molded from glass filled polymer.

94740



SURESHELL CARRIER 4-SHELL

SureShell carrier for Remington 870 (4-shells, 12 gauge/left side) • Weight: 7 oz

90320



SURESHELL CARRIER AND RAIL 4-SHELL

Using the top mounting screw holes found on the Beretta 1301 shotguns. The SureShell shot-shell carriers are thus slung on the left side of the receiver, securely fastened at the top.

91210



SURESHELL CARRIER AND RAIL 6-SHELL

Using the top mounting screw holes found on the Beretta 1301 shotguns. The SureShell shot-shell carriers are thus slung on the left side of the receiver, securely fastened at the top.

91220



CROSSHAIR HYDRAULIC RECOIL BUFFER

The Crosshair buffer tube reduces felt recoil by up to 70% while improving accuracy.

92190



HIGH-TUBE TELESCOPING

High-tube adapters have a comb height equivalent to an AR-15 and require an optics rail.

95360



PUSH BUTTON SLING SWIVEL

Our Push-button Sling Swivel Mount for Remington is secured to the shotgun in the same way as the sling loop • For 1/4" webbing

91190



PICATINNY RAIL

Top mount picatinny rail for Remington • Length: 5 inch

92370



OPEN

MI™ MIDWEST INDUSTRIES



- 25. Trigger spring
- 25a. New York Trigger Spring 1
- 25b. New York Trigger Spring 2
- 26. Trigger with trigger bar
- 27. Slide stop lever
- 28. Trigger

ng
ew
ch spring
ch

HANDGUARDS



AKG2 BULGARIAN KRINK M-LOK

Universal AK handguard design fits most Bulgarian Krinkovs and variants

MI-AKG2-BKM



Y92M MLOK RAILED TOP

Fits M92 Yugo patterned rifles and pistols • Weight only 7.5 ounces

MI-AKG2-Y92M



SCORPION 4.25 M-LOK

Weights only 7.8 oz • Length: 4.25" • Width: 1.80" • OAL Height: 3.2" • Internal Diameter: 1.625"

MI-CZ4.25M



SCORPION 6.75 M-LOK

Weights: 10.9 oz • Length: 6.75" • Width: 1.80" • OAL Height: 3.2" • Internal Diameter: 1.625"

MI-CZ6.75M



SCORPION 11.5 M-LOK

Weights: 17.0 oz • Length: 11.5" • Width: 1.80" • OAL Height: 3.2" • Internal Diameter: 1.625"

MI-CZ11.5M



7.62 X 39 PISTOL GALIL ACE

Length: 6.25" • Slim: 1.6 width gives your Galil a great ergonomic feel • Width: 1.64" • Weight: 4.3 oz

MI-GACEP



7.62 X 39 RIFLE GALIL ACE

Length: 10" • Width: 1.64" • Weight: 6.6 oz • Slim: 1.6 width gives your Galil a great ergonomic feel

MI-GACER



.308 PISTOL GALIL ACE

Length: 7.75 inches • Width: 1.64 inches • Weight: 5.2 oz • Extremely lightweight design

MI-GA308P



.308 RIFLE GALIL ACE

Length: 10" • Weight: 6.6 oz • Weight: 2.6 oz with hardware • Width: 1.64"

MI-GA308R



.308 EXTENDED RIFLE GALIL ACE

Length: 12.5" • Width: 1.64" • Weight: 8.2 oz • Slim: 1.6" diameter for a great feel • Anti-rotation QD sockets for easy sling attachment

MI-GA308XR



.308 PISTOL GALIL ACE

Length: 6.25 inches • Width: 1.64 inches • Weight: 4.3 oz • Slim 1.6 width gives your Galil a great ergonomic feel

MI-GA556P



.308 RIFLE GALIL ACE

Length: 10 inches • Width: 1.64" • Weight: 6.6 oz • Weight: 2.6 oz with hardware • Slim: 1.6" diameter for a great feel • Extremely lightweight design

MI-GA556R

HANDGUARDS



5.56 GALIL ACE EXTENDED RIFLE

Length 12.5" • Width 1.64" • Weight 8.2 oz • Slim 1.6" diameter for a great feel • Anti-rotation QD sockets for easy sling attachment

MI-GA556XR



SCORPION 11.5 M-LOK

Weights only 17 oz • Length 11.5 • Width 1.80" • OAL Height 3.2" • Internal Diameter 1.625"

MI-HENMR30-30



H591M

Extremely lightweight design, weighs only 8.6 oz with all hardware • Slim 1.6 inch diameter for a great feel

MI-HK91M



HK93M

Extremely lightweight design, weighs only 7.1 oz with all hardware • Slim 1.6 inch diameter for a great feel

MI-HK93M



SIG MPX 4.5 M-LOK

Length 4.5" • Width 2.06" • OAL height 2.6" • Internal Diameter 1.8" • Weighs only 3.0 ounces

MI-MPX4.5M



SIG MPX 10.5 M-LOK

Length 10.5" • Width 2.06" • Internal Diameter 1.8" • Weighs only 8.8 ounces • OAL height 2.6"

MI-MPX10.5M



SIG MPX 6.5 M-LOK

Length 6.5" • Width 2.06" • Internal Diameter 1.8" • Weighs only 5.0 ounces • OAL height 2.6"

MI-MPX6.5M



SIG MPX 8.0 M-LOK

Length 8.0" • Width 2.06" • Internal Diameter 1.8" • Weighs only 6.6 ounces • OAL height 2.6"

MI-MPX8.0M



MCX VIRTUS SUPPRESSOR 10"

Length 10" • Width 1.975" • Grip Height 2.4" • Internal Diameter 1.75" • Weighs only 7.5 ounces • OAL height 2.64"

MI-MCXVSP10



MCX VIRTUS SUPPRESSOR 15.25"

Length 15.25" • Width 1.975" • OAL height 2.64" • Internal Diameter 1.75" • Weighs only 12.5 oz

MI-MCXVSP15.25



MCX-VIRTUS 10.5"

Length 10.5" • Width 1.67" • Grip Height 2.4" • Internal Diameter 1.46" • Weighs only 7.46 ounces • OAL height 2.6"

MI-MCXV10.5



MCX-VIRTUS 12.5"

Length 12.5" • Width 1.67" • Grip Height 2.4" • Internal Diameter 1.46" • Weighs only 8.7 ounces • OAL height 2.6"

MI-MCXV12.5

HANDGUARDS



SIG MPX 14 M-LOK

Length 14" • Width 2.06" • OAL height 2.6" • Internal Diameter 1.8" • Weighs only 12.1 ounces
MI-MPX14M



SIG RATTLER 10" M-LOK

MI Sig Rattler 10" Advanced ergonomic shape improves the feel and handling of your Sig Rattler • Weight 8.6 oz
MI-SIGR5P-10



SP89M

MI HK SP89/MP5K: Professional grade one piece design • Weight only 2.6 oz with hardware • Slim 1.6" diameter for a great feel
MI-SP89M



7" COMBAT RAIL M-LOK

7" overall length • 6.8 oz Installed Weight • Super Slim 1.5" Outside and 1.3" Inside Diameter
MI-CRM7



9.25" COMBAT RAIL M-LOK

9.25" overall length • 8.0 oz installed weight • 5-Slot polymer M-Lok rail included
MI-CRM9.25



10.5" COMBAT RAIL M-LOK

10.50" overall length • 8.3 oz installed weight • 5-Slot Polymer M-Lok rail included
MI-CRM10.5



12.625" COMBAT RAIL M-LOK

12.625" overall length • 9.9 oz Installed Weight • Super Slim 1.5" Outside and 1.3" Inside Diameter
MI-CRM12.625



14" COMBAT RAIL M-LOK

14" overall length • 10.8 oz installed weight • 5-Slot polymer M-Lok rail included
MI-CRM14



15" COMBAT RAIL M-LOK

15" overall length • 11.4 oz installed weight • 5-Slot Polymer M-Lok rail included
MI-CRM15



10.5" ULTRALIGHT HANDGUARD

10.5" overall length • 6.8 oz installed weight
MI-ULW10.5



12.625" ULTRALIGHT HANDGUARD

12.625" overall length • 7.9 oz installed weight
MI-ULW12.625



14" ULTRALIGHT HANDGUARD

14" overall length • 8.4 oz installed weight
MI-ULW14

 **NOVESKE**



FLASH SUPPRESSORS

KX5-556

The Noveske KX5 Flash Suppressor will work on any barrel length. All KX5 are individually serial numbered for quality control and come with a crush washer for timing purposes. You asked, we listened. New slim design allows installation under the Noveske Handguard. KX5-556, 1/2x28 Thread, 1/2 Crush Washer.

05000517



FEATURES

Made in Grants Pass, Oregon USA

- Heat-Treated CM Construction
- Nitride Finish
- 4.5 ounces
- 1.2 inch Dia
- 3.25 inch OAL

This KX5 may be used on: 5.56 mm = 1/2x28 and 300 Blackout, 6.8 SPC, 7.62 mm = 5/8x24

KX3-556

The Noveske KX3 Flash Suppressor will work on any barrel length. All KX3 are individually serial numbered for quality control and come with a crush washer for timing purposes. Flash Suppressor, KX3-556P, 1/2x28 Thread, 1/2 Crush Washer.

05000519



FEATURES

Made in Grants Pass, Oregon USA

- Heat-Treated CM Construction
- Black Nitride Finish on 1/2 x 28 & 5/8 x 24
- Phosphate Finish on M15x1 & M14x1LH
- 7 ounces
- 1.35 inch Dia
- 3.28 inch OAL

This KX3 may be used on: 5.56 mm = 1/2x28 300 Blackout and 6.8, & 7.62 = 5/8x24



PHASE 5
WEAPON SYSTEMS INC.



CHARGING HANDLE



BATTLE LATCH

Battle latch/charging handle assembly incorporates an upgraded .1875 mm stainless coiled spring pin and increased sidewall thickness to provide exceptional performance under repeated abuse • Overall length: 6.75" • Weight: 42.6 grams

BL/CHA

BUFFER TUBE



HEXONE AR15

The HexOne Rifle Buffer Tube is precision machined in house from USA sourced raw billet aluminum. The HexOne buffer tube is cut from 7075-T7 • Weight: 8.3 oz • Length: 10"

HEXONE-R-TUBE

RECEIVER



A3 FLAT TOP COMPLETE UPPER RECEIVER

Flat top upper receiver, complete • Mil-spec type III hard coat anodizing • Precision machined to M16/M4 specs • M4 feedramps

A3-UPPER

FIREARM PARTS & ACCESSORIES



WINTER TRIGGER GUARD

The newly revised Phase 5 winter trigger guard is aggressively styled.

WTG



AMBI CHARGING HANDLE LATCH

The Phase 5 Tactical ACHL gives the operator the ability to utilize the charging handle in a more effective manner.

ACHL



GAS TUBE

Phase 5 gaz tubes are available in carbine / Mid-length and rifle length.

GAS TUBE - MID



RADIANT MODEL 1

THE RIFLE EVOLVED

RAPTOR-SD
AMBIDEXTROUS
CHARGING HANDLE

BILLET MACHINED
7075-T6 UPPER &
LOWER RECEIVER

M-LOK® MODULAR
ACCESSORY MOUNTING
SYSTEM

TALON MODULAR
AMBIDEXTROUS 45/90
SAFETY SELECTOR

FULL AMBIDEXTROUS
CONTROLS INCLUDING
A-DAC RIGHT-SIDE
BOLT HOLD OPEN

MATCH GRADE
416 STAINLESS
STEEL BARREL



JOIN THE RAPTOR FAMILY
**RAPTOR AMBIDEXTROUS
CHARGING HANDLES**



TALON & RIFLE PARTS



TALON AMBIDEXTROUS - 4 LEVER

The Talon ambidextrous safety selector is a modular design that can be installed as a standard 90° or as a 45°.

R0015



TALON AMBIDEXTROUS - 2 LEVER

The Talon ambidextrous safety selector is a modular design that can be installed as a standard 90° or as a 45°.

R0018



AR15 TAKEDOWN PIN KIT

Precision CNC machined steel takedown pin set for AR15/M16 w/ black nitride finish and engraved Radian logo.

R0077

Remington
LAW ENFORCEMENT





18" 870P BS SPEEDFEED
24461

| CALIBER | OPERATION | BARREL LENGTH | OVERALL LENGTH | SIGHT | WEIGHT |
|---------------------|-----------|---------------|----------------|-------|----------|
| 12 Gauge 3" (76 mm) | Pump | 18" | 38.5" | Bead | 7.25 lbs |



18" 870P BS WALNUT
24901

| CALIBER | OPERATION | BARREL LENGTH | OVERALL LENGTH | SIGHT | WEIGHT |
|---------------------|-----------|---------------|----------------|-------|----------|
| 12 Gauge 3" (76 mm) | Pump | 18" | 38.5" | Bead | 7.25 lbs |



18" 870P BS 6+1 WALNUT
24903

| CALIBER | OPERATION | BARREL LENGTH | OVERALL LENGTH | SIGHT | WEIGHT |
|---------------------|-----------|---------------|----------------|-------|----------|
| 12 Gauge 3" (76 mm) | Pump | 14" | 38.5" | Bead | 7.25 lbs |



18" 870P BS
24403

| CALIBER | OPERATION | BARREL LENGTH | OVERALL LENGTH | SIGHT | WEIGHT |
|---------------------|-----------|---------------|----------------|-------|----------|
| 12 Gauge 3" (76 mm) | Pump | 18" | 38.5" | Bead | 7.25 lbs |



18" 870P BS 6+1
24407

| CALIBER | OPERATION | BARREL LENGTH | OVERALL LENGTH | SIGHT | WEIGHT |
|---------------------|-----------|---------------|----------------|-------|----------|
| 12 Gauge 3" (76 mm) | Pump | 18" | 38.5" | Bead | 7.25 lbs |



20" 870P BS WALNUT - BLUE POLISHED
24899

| CALIBER | OPERATION | BARREL LENGTH | OVERALL LENGTH | SIGHT | WEIGHT |
|---------------------|-----------|---------------|----------------|-------|----------|
| 12 Gauge 3" (76 mm) | Pump | 20" | 38.5" | Bead | 7.25 lbs |



14" 870P RS
24431

| CALIBER | OPERATION | BARREL LENGTH | OVERALL LENGTH | SIGHT | WEIGHT |
|---------------------|-----------|---------------|----------------|-------------|---------|
| 12 Gauge 3" (76 mm) | Pump | 14" | 36.5" | Rifle Sight | 7.1 lbs |



18" 870P RS 6+1 PISTOL GRIP
27393

| CALIBER | OPERATION | BARREL LENGTH | OVERALL LENGTH | SIGHT | WEIGHT |
|---------------------|-----------|---------------|----------------|-------|---------|
| 12 Gauge 3" (76 mm) | Pump | 18" | 37.5" | Rifle | 8.5 lbs |



18" 870P RS 6+1
24421

| CALIBER | OPERATION | BARREL LENGTH | OVERALL LENGTH | SIGHT | WEIGHT |
|---------------------|-----------|---------------|----------------|-------|----------|
| 12 Gauge 3" (76 mm) | Pump | 18" | 38.5" | Rifle | 7.25 lbs |



18" 870P RS COLLAPSIBLE
24593

| CALIBER | OPERATION | BARREL LENGTH | OVERALL LENGTH | SIGHT | WEIGHT |
|---------------------|-----------|---------------|----------------|-------|----------|
| 12 Gauge 3" (76 mm) | Pump | 14" | 35.75" | Rifle | 7.75 lbs |



18" 870P RS IMPROVED CYLINDER
27575

| CALIBER | OPERATION | BARREL LENGTH | OVERALL LENGTH | SIGHT | WEIGHT |
|---------------------|-----------|---------------|----------------|-------|----------|
| 12 Gauge 3" (76 mm) | Pump | 18" | 35.5" | Rifle | 7.25 lbs |



18" 870P RS TRITIUM
24419

| CALIBER | OPERATION | BARREL LENGTH | OVERALL LENGTH | SIGHT | WEIGHT |
|---------------------|-----------|---------------|----------------|-------|----------|
| 12 Gauge 3" (76 mm) | Pump | 18" | 38.5" | Rifle | 7.25 lbs |



20" 870P RS WALNUT
24888

| CALIBER | OPERATION | BARREL LENGTH | OVERALL LENGTH | SIGHT | WEIGHT |
|---------------------|-----------|---------------|----------------|-------|----------|
| 12 Gauge 3" (76 mm) | Pump | 20" | 40.5" | Rifle | 7.75 lbs |



20" 870P RS SYNTHETIC
24401

| CALIBER | OPERATION | BARREL LENGTH | OVERALL LENGTH | SIGHT | WEIGHT |
|---------------------|-----------|---------------|----------------|-------|----------|
| 12 Gauge 3" (76 mm) | Pump | 20" | 40" | Rifle | 7.25 lbs |



14" 870P GHOST RING 5+1 PISTOL GRIP
27407

| CALIBER | OPERATION | BARREL LENGTH | OVERALL LENGTH | SIGHT | WEIGHT |
|---------------------|-----------|---------------|----------------|-------|---------|
| 12 Gauge 3" (76 mm) | Pump | 14" | 35.5" | Ghost | 8.1 lbs |



14" 870P GHOST RING MODIFIED
82686

| CALIBER | OPERATION | BARREL LENGTH | OVERALL LENGTH | SIGHT | WEIGHT |
|---------------------|-----------|---------------|----------------|-------|---------|
| 12 Gauge 3" (76 mm) | Pump | 14" | 35.5" | Ghost | 7.1 lbs |



18" 870P GHOST RING 6+1
24447

| CALIBER | OPERATION | BARREL LENGTH | OVERALL LENGTH | SIGHT | WEIGHT |
|---------------------|-----------|---------------|----------------|-------|----------|
| 12 Gauge 3" (76 mm) | Pump | 18" | 38.5" | Ghost | 7.25 lbs |



18" 870P GHOST RING
24449

| CALIBER | OPERATION | BARREL LENGTH | OVERALL LENGTH | SIGHT | WEIGHT |
|---------------------|-----------|---------------|----------------|-------|----------|
| 12 Gauge 3" (76 mm) | Pump | 18" | 38.5" | Ghost | 7.25 lbs |



R12
82795

| CALIBER | OPERATION | BARREL LENGTH | OVERALL LENGTH | SIGHT | WEIGHT |
|---------------------|-----------|---------------|----------------|-------|---------|
| 12 Gauge 3" (76 mm) | ? | 18" | 39.5" | Ghost | 7.2 lbs |



18" 870P LOW PROFILE RS 6+1 COLLAPSIBLE
82629

| CALIBER | OPERATION | BARREL LENGTH | OVERALL LENGTH | SIGHT | WEIGHT |
|---------------------|-----------|---------------|----------------|-------------|---------|
| 12 Gauge 3" (76 mm) | Pump | 18" | 35.75" | Low profile | 8.8 lbs |



11" R4 ENHANCED
86570

| CALIBER | OPERATION | BARREL LENGTH | OVERALL LENGTH | TWIST | WEIGHT |
|-----------|-----------|---------------|----------------|-------|--------|
| 5.56 NATO | Semi-Auto | 11" | 32.5" | N/A | 7 lbs |



14.5" R4 ENHANCED
86357

| CALIBER | OPERATION | BARREL LENGTH | OVERALL LENGTH | TWIST | WEIGHT |
|-----------|-----------|---------------|----------------|------------|---------|
| 5.56 NATO | Semi-Auto | 14.5" | 38.5" | 1:7 / 1:10 | 8.8 lbs |



11.5" R4 PATROL
86542

| CALIBER | OPERATION | BARREL LENGTH | OVERALL LENGTH | TWIST | WEIGHT |
|-----------|-----------|---------------|----------------|-------|----------|
| 5.56 NATO | Semi-Auto | 11.5" | 28" | 1:7 | 6.75 lbs |



R10
86361

| CALIBER | OPERATION | BARREL LENGTH | OVERALL LENGTH | TWIST | WEIGHT |
|---------------------|-----------|---------------|----------------|-------|---------|
| 7.62 NATO / .08 Win | Semi-Auto | 16" | 35.1" | 1:10 | 8.8 lbs |



MODEL 700 LTR
25737

| CALIBER | OPERATION | BARREL LENGTH | OVERALL LENGTH | TWIST | WEIGHT |
|-------------------------|-------------|---------------|----------------|----------------------|----------|
| 223 Remington / 308 Win | Bolt Action | 20" | 41" | 1-9 / 1-10 / 1-10 5R | 7.50 lbs |



11" 870 BREACHER
CYLINDER COLLAPSIBLE
86673

| CALIBER | OPERATION | BARREL LENGTH | OVERALL LENGTH | SIGHT | WEIGHT |
|---------------------|-----------|---------------|--------------------|-------|---------|
| 12 Gauge 3" (76 mm) | Pump | 11" | 29.75" (Collapsed) | N/A | 7.2 lbs |



AMMUNITIONS

RIFLE TRAINING



DISINTEGRATOR LEAD-FREE JACKETED, FRANGIBLE

Disintegrator Jacketed frangible ammo is a totally lead-free and heavy-metal-free, frangible training load for realistic, safe and cost-effective training and qualification programs. **23896**

| CARTRIDGE | BULLET STYLE | BULLET WEIGHT (GRS.) |
|---------------|--|----------------------|
| 223 Remington | Lead-Free Jacketed, Powdered Metal Core, Frangible | 55 |



UMC RIFLE AMMUNITION

For varmint hunting, target shooting, training exercises or any other high-volume shooting situation UMC centerfire rifle ammunition offers value without any compromise in quality or performance. **23711**

| CARTRIDGE | BULLET STYLE | BULLET WEIGHT (GRS.) |
|----------------------|--------------|----------------------|
| 223 Remington | FMJ | 55 |
| 6.8 mm Remington SPC | FMJ | 115 |
| 308 Win. | FMJ | 150 |
| 223 Remington | FMJ | 55 |

RIFLE DUTY



PREMIER ACCUTIP

Expect dynamite results. In varmint calibers, AccuTip-V combines superb flight characteristics and match-grade accuracy with a design optimized for explosive on-game results. At impact, AccuTip's gold polymer tip is driven rearward causing the thin jacket and soft lead core to fragment violently.

29192

| CARTRIDGE | BULLET STYLE | BULLET WEIGHT (GRS.) |
|---------------|--------------------|----------------------|
| 223 Remington | AccuTip | 55 |
| 300 Win. Mag. | AccuTip, Boat Tail | 180 |
| 308 Win. | AccuTip, Boat Tail | 165 |



REMINGTON PREMIER CORE-LOKT ULTRA BONDED

Well they're probably talking about Remington Premier Match ammunition. Using only match-grade bullets, Premier Match ammunition employs special loading practices to ensure world-class performance and accuracy with every shot.

21485

| CARTRIDGE | BULLET STYLE | BULLET WEIGHT (GRS.) |
|---------------|------------------------|----------------------|
| 223 Remington | Core-Lokt Ultra Bonded | 62 |
| 308 Win. | Core-Lokt Ultra Bonded | 150 |
| 308 Win. | Core-Lokt Ultra Bonded | 180 |



CORE-LOKT

Remington Core-Lokt a reputation deserved. Hunters with a knack for filling their deer tag tend to have more than success in common. They trust their hunt to Remington Core-Lokt. For more than six decades, it has remained the leader in centerfire deer ammunition.

27828

| GAUGE | CENTERFIRE CARTRIDGES | BULLET WEIGHT (GRS.) |
|-------|-----------------------|----------------------|
| 12 | Core-Lokt | 180 |

HANDGUN TRAINING



UMC LEADLESS

Disintegrator Jacketed frangible ammo is a totally lead-free and heavy-metal-free, frangible training load for realistic, safe and cost-effective training and qualification programs. **23793**

| CARTRIDGE | BULLET STYLE | BULLET WEIGHT (GRS.) |
|------------|--------------|----------------------|
| 9 mm Luger | FNEB | 115 |
| 380 Auto | FNEB | 95 |
| 40 S&W | FNEB | 180 |
| 45 Auto | FNEB | 230 |



UMC

For practice, target shooting, training exercises or any other high-volume shooting situation UMC centerfire pistol and revolver ammunition offers value without any compromise in quality or performance. **23742**

| CARTRIDGE | BULLET STYLE | BULLET WEIGHT (GRS.) |
|------------|--------------|----------------------|
| 9 mm Luger | JSP | 125 |
| 9 mm Luger | FMJ | 124 |
| 9 mm Luger | FMJ | 115 |
| 9 mm Luger | FMJ | 147 |
| 40 S&W | FMJ | 165 |

HANDGUN TRAININGS



DISINTEGRATOR CTF LEAD-FREE FRANGIBLE AMMUNITION

Disintegrator CTF (Copper/Tin Frangible), Lead Free Sintered Pistol and Revolver ammunition offers the most complete bullet break-up and minimal splash back available in reduced hazard training ammunition. For your most demanding close-quarter training needs.

29460

| CARTRIDGE | BULLET STYLE | BULLET WEIGHT (GRS.) |
|-----------------|--|----------------------|
| 9 mm Luger +P ‡ | Lead-Free Jacketless, Copper/Tin Sintered, Frangible | 100 |
| 40 S&W | Lead-Free Jacketless, Copper/Tin Sintered, Frangible | 125 |
| 45 Auto | Lead-Free Jacketless, Copper/Tin Sintered, Frangible | 155 |

HANDGUN DUTY



GOLDEN SABER BLACK BELT

Introducing Golden Saber Black Belt – engineered in conjunction with law enforcement professionals, for law enforcement professionals, and now available to anyone seeking the pinnacle of stopping power. Extensively proven in FBI barrier testing to deliver massive, reliable expansion and deep penetration in every medium.

29437

| CARTRIDGE | BULLET STYLE | BULLET WEIGHT (GRS.) |
|---------------|----------------------------------|----------------------|
| 9 mm Luger | Black Belt Jacketed Hollow Point | 124 |
| 9 mm Luger +P | Black Belt Jacketed Hollow Point | 124 |
| 40 S&W | Black Belt Jacketed Hollow Point | 180 |
| 45 Auto | Black Belt Jacketed Hollow Point | 230 |

HANDGUN DUTY



GOLDEN SABER BONDED

All the revolutionary features that make Golden Saber rounds the leading edge in tactical handgun rounds, along with the unmatched barrier penetration performance of our special bonded-bullet design. The standard for barrier-penetration performance.

29353

| CARTRIDGE | BULLET STYLE | BULLET WEIGHT (GRS.) |
|------------------|---|----------------------|
| 9 mm Luger | Brass-Jacketed Hollow Point, Bonded | 125 |
| 9 mm Luger (+P)1 | Brass-Jacketed Hollow Point, Bonded (+P)2 | 124 |
| 9 mm Luger (+P)1 | Brass-Jacketed Hollow Point, Bonded | 147 |
| 40 S&W | Brass-Jacketed Hollow Point, Bonded | 165 |



HEAVY CLOTHING @ 10 FEET

| | | |
|---|---|--|
|  |  | 9MM LUGER Weight: 147-gr. Penetration: 16.9" Expansion: .58" (1.6x) Weight Retention: 100% |
|  |  | 40 S&W Weight: 180-gr. Penetration: 14.4" Expansion: .67" (1.7x) Weight Retention: 100% |
|  |  | 45 AUTO Weight: 230-gr. Penetration: 16.1" Expansion: .71" (1.6x) Weight Retention: 100% |

AUTO GLASS @ 10 FEET

| | | |
|---|---|---|
|  |  | 9MM LUGER Weight: 147-gr. Penetration: 12.1" Expansion: .55" (1.6x) Weight Retention: 92% |
|  |  | 40 S&W Weight: 180-gr. Penetration: 11.2" Expansion: .62" (1.6x) Weight Retention: 97% |
|  |  | 45 AUTO Weight: 230-gr. Penetration: 12.5" Expansion: .63" (1.4x) Weight Retention: 96% |

WALLBOARD @ 10 FEET

| | | |
|---|---|---|
|  |  | 9MM LUGER (WALLBOARD) Weight: 147-gr. Penetration: 13.8" Expansion: .60" (1.7x) Weight Retention: 100% |
|---|---|---|

STEEL @ 10 FEET

| | | |
|---|---|---|
|  |  | 9MM LUGER (STEEL) Weight: 147-gr. Penetration: 21.4" Expansion: .42" (1.2x) Weight Retention: 100% |
|---|---|---|

HANDGUN DUTY



BJHP HIGH PERFORMANCE JACKET

All the revolutionary features that make Golden Saber rounds the leading edge in tactical handgun rounds, along with the unmatched barrier-penetration performance of our special bonded-bullet design.

29400

| CARTRIDGE | BULLET STYLE | BULLET WEIGHT (GRS.) |
|------------|-----------------------------------|----------------------|
| 9 mm Luger | Brass-Jacketed Hollow Point | 124 |
| 9 mm Luger | Brass-Jacketed Hollow Point (+P)1 | 124 |
| 9 mm Luger | Brass-Jacketed Hollow Point | 147 |
| 380 Auto | Brass-Jacketed Hollow Point | 102 |
| 38 Special | Brass-Jacketed Hollow Point (+P) | 125 |
| 40 S&W | Brass-Jacketed Hollow Point | 165 |
| 40 S&W | Brass-Jacketed Hollow Point | 180 |
| 45 Auto | Brass-Jacketed Hollow Point | 185 |
| 45 Auto | Brass-Jacketed Hollow Point | 230 |
| 45 Auto | Brass-Jacketed Hollow Point (+P) | 185 |

HEAVY CLOTHING @ 10 FEET

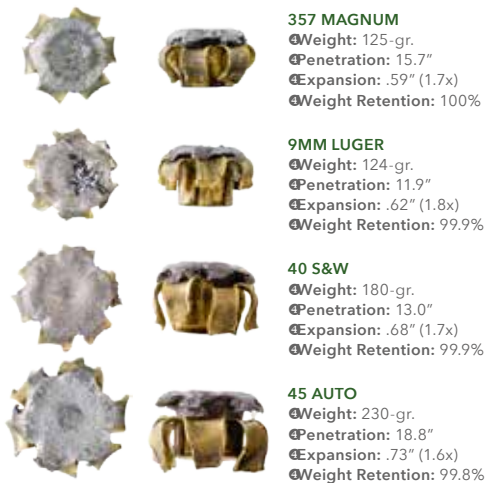

HEAVY CLOTHING @ 20 YARDS



WALLBOARD @ 10 FEET

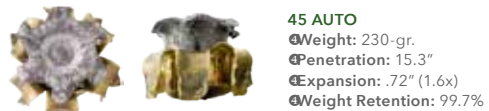

STEEL @ 10 FEET

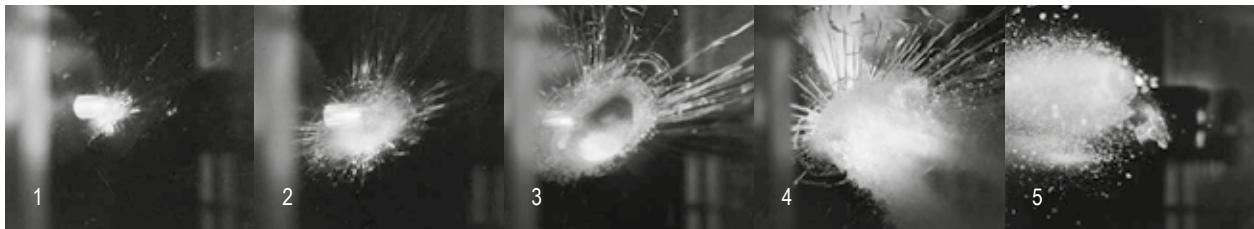

SHOTSHEEL BUCKSHOT



TACTICAL BUCKSHOT LE

Remington slug hulls are now offered in optional Peters blue for rapid differentiation from buckshot loads. All buckshot hulls remain in standard "Remington Green". With this Remington feature, personnel can easily distinguish between slugs and buckshot loads.
20811

| GAUGE | SLUG WEIGHT | SHELL LENGTH (IN.) |
|-------|-------------|--------------------|
| 12 | 00 Buck | 2 3/4" |



TAC 8 00-BUCKSHOT

A full load 8-pellet 00-Buck that boasts a highly concentrated 1/2" to 3/4" per yard pattern spread. Pattern controlled by utilizing 00-buck with 3% antimony lead and a precisely loaded special shot cup. Waterproof primer and mouth for maximum reliability under harsh environmental conditions.
20662

| GAUGE | SHOTGUN SHELL | SHELL LENGTH (IN.) |
|-------|--------------------------------|--------------------|
| 12 | Law Enforcement Buckshot Loads | 2 3/4" |



REDUCED-RECOIL 00-BUCKSHOT

Our 9-pellet 00-Express LE Buckshot created a new standard of pattern performance with the addition of our one piece compression section Power Piston wad column, polymer buffering and hard lead pellets. This combination produces patterns 25% tighter than previous buckshot offerings.
20812

| GAUGE | SHOTGUN SHELL | SHELL LENGTH (IN.) |
|-------|--------------------------------|--------------------|
| 12 | Law Enforcement Buckshot Loads | 2 3/4" |

SHOTSHEEL DUTY



SLUGGER RIFLED SLUGS

Remington slug hulls are now offered in optional Peters blue for rapid differentiation from buckshot loads. All buckshot hulls remain in standard "Remington Green". With this Remington feature, personnel can easily distinguish between slugs and buckshot loads.

20300

| GAUGE | OUNCES | SHELL LENGTH (IN.) |
|-------|--------|--------------------|
| 12 | 1 oz | 2 3/4" |



REDUCED RECOIL RIFLED SLUGS

12 gauge slugs are available in full power and reduced recoil for duty and training conditions. While the Slugger Rifled Slugs remain the industry standard, the Reduced Recoil Rifled Slugs generate 45% less recoil than a standard 1 oz. rifled slug. In the field or on the course, Remington provides the perfect slugs for any shotgun duty use.

20285

| GAUGE | SHOTGUN SHELL | SHELL LENGTH (IN.) |
|-------|----------------------------------|--------------------|
| 12 | Managed-Recoil Rifled Slug Loads | 2 3/4" |

TRAINING AND WILDLIFE MANAGMENTS



SPORTSMAN HI-SPEED STEEL HIGH VELOCITY, HIGH VALUE

The Waterfowl hunter is up when they sleep, to go out into the cold, the wind and the wet, knowing the temperature may not climb above freezing. They hunker for woodies, sprigs, and greenheads amongst the reeds and farm ponds. Remington understands how you hunt, what you hunt, and what you expect from your equipment.

20005

| GAUGE | SHOTGUN SHELL | SHELL LENGTH |
|-------|--------------------------------|--------------|
| 12 | Sportsman Hi-Speed Steel Loads | 2" 3/4 |



GUN CLUB TARGET LOADS

Remington's Target Loads have taken shot-to-shot consistency to a new performance level, setting the standard at all major skeet, trap, and sporting clays shoots across the country, while providing handloaders with unmatched reloading ease and hull longevity.

20232

| GAUGE | SHOTGUN SHELL | SHELL LENGTH |
|-------|-----------------------|--------------|
| 12 | Gun Club Target Loads | 2" 3/4 |



MATCH EPS

When it comes to competition-grade rimfire ammunition, there's only one name good enough to share the Remington brand – Eley. Building on the rimfire expertise of Eley, Ltd., and its reputation among dedicated rimfire shooters as the world's most accurate and reliable ammunition.

21259

| CALIBRE | RIMFIRE CARTRIDGES | WEIGHT (GRAIN) |
|---------|--------------------|----------------|
| 22 LR | Eley Competition | 40 |

TRAINING AND WILDLIFE MANAGMENTS



22 THUNDERBOLT

Prairie dogs. Tin cans. Or a bulls-eye. No matter what you put in your sights, Remington offers the perfect 22 rimfire ammunition for any occasion. Remington rimfire ammunition delivers the quality you expect. That's because we put the same level of care into making our rimfire ammunition as we do our centerfire ammunition, so you'll get the maximum performance from every shot.

21238

| CALIBRE | RIMFIRE CARTRIDGES | WEIGHT (GRAIN) |
|---------|--------------------|----------------|
| 22 LR | Remington Rimfire | 40 |

SHOTSHEEL TRAINING



DISINTEGRATOR LEAD-FREE FRANGIBLE

Reliable lead-free and heavy-metal-free primer. Lead-free slugs produce instant, complete breakup when impacting steel targets and steel backstops. Optimized powder blends for efficient utilization with minimum unburned residue.

20810

| CALIBRE | RIMFIRE CARTRIDGES | SHELL LENGTH |
|---------|---|--------------|
| 12 | Disintegrator Lead Free Frangible Sabot Slugs | 2" 3/4 |

TIMNEY
TRIGGERS USA

TRIGGERS



AR-10 COMPETITION TRIGGERS

The Timney AR-10 trigger is a self-contained, 100% drop-in unit ready to install in any Mil-Spec AR-10 rifle for an exceptionally smooth, crisp, single-stage. Available in straight or a curved trigger lever.

670



AR PCC TWO STAGE TRIGGER

The AR PCC 2 Stage Complete Trigger Assembly! Featuring a 2+2 pound pull weight, the AR PCC Drop-In 2 Stage Complete Trigger makes use of your rifle's existing hammer/trigger pins and safety.

682



AR PCC TRIGGER

From Timney, an AR PCC Trigger! A drop-in complete trigger assembly, featuring a pull weight of 2.5-3 pounds for both the curved and straight models.

681



AR CALVIN ELITE SINGLE STAGE DROP-IN

Upgrade your AR/M4 platform rifle with these Timney Triggers Calvin Elite AR Triggers that will greatly enhance your shooting experience. Fully adjust the length of pull, cast, and height of these Timney Triggers Calvin Elite Single Stage Triggers to customize your experience. Compatible with all Military Spec Built Lowers.

660CE



AR-15 SOLID DROP-IN TRIGGER MODULE

Self-contained module is ready to install in your small-pin AR and deliver an exceptionally smooth, crisp, creep-free single-stage trigger pull that feels more like a traditional bolt action than a combat rifle trigger. Available with standard solid trigger shoe with choice of 3 lb, 4 lbs or 4.5 lbs pull weight.

6675



REMINGTON 700 HIT TRIGGER

The HIT is robust and features Timney new Sear Engagement Adjustment Lock design (SEAL'd) that ensures a user-friendly experience, is adjustable for pull weight and overtravel, yet delicate enough to be set with a pull weight as low as 8 ounces up to 2 pounds. Available with a curved or straight trigger shoe.

THE HIT



REMINGTON 700 CALVIN ELITE

An engineering accomplishment, adjustable from 8 oz to 2.0 pounds. For the discriminating shooter, demanding the utmost performance from their trigger, the Remington 700 Calvin Elite trigger is designed to be robust and yet delicate enough to be set with a pull weight as low as 8 oz.

520CE



REMINGTON 700 2 STAGE

The Timney 2 Stage Trigger is available in either straight or curved models. The pull weight is factory calibrated for an 1 lb first stage and one -pound second stage (the second stage is adjustable from 1 lb to 4 lbs of pull weight).

670-ST



REM 870 TRIGGER FIX

Designed to work with all Model 870 shotguns, the Trigger Fix allows the user to have a clean, smooth, fully adjustable trigger pull.

870

 WEAPON SYSTEMS

9262012

BLACK

FIRE

SAFE

4

3

ducts

HANDGUARDS



ULTRA-LIGHT LITH/ALU HANDGUARD 10.75" KEYMOD

Compatibility: AR10, DPMS 308 • Fit 308DPMS/
SR25 large/high platform • Length: 10.75"
ULIGHT 10.75KM308



DARKLITE MAGNESIUM M-LOK 13.5"

M-LOK design for ar15 platform • Slim design
with an ID of 1.3"(left to right) & 1.55" • Length:
13.5 in • Width: 1.5 in • Height: 1.97 in
DLITE 13.5ML



DARKLITE MAGNESIUM M-LOK 15"

M-LOK design for ar15 platform • Slim design
with an ID of 1.3"(left to right) & 1.55" • Length:
15 in • Width: 1.5 in • Height: 1.97 in
DLITE 15ML



ULTRA-LIGHT LITH/ALU HANDGUARD 13.5" M-LOK

Compatibility: AR15 • Length: 13.5" • Width:
1.67" • Height: 2.15" • Weighs approx: 8.6 oz
ULIGHT 13.5ML308



ULTRA-LIGHT LITH/ALU HANDGUARD 15" M-LOK

Compatibility: AR15 • Length: 15.0" • Width:
1.5" • Height: 1.97" • Weighs approx: 7.7 oz
ULIGHT 15ML



ULTRA-LIGHT LITH/ALU HANDGUARD 16.5" M-LOK

Compatibility: AR15 • Length: 16.5" • Width:
1.5" • Height: 1.97" • Weighs approx: 8.3 oz
ULIGHT 16.5ML

HANDGUARDS



ULTRA-LIGHT LITH/ALU 9" M-LOK

Compatibility: AR15 • Length: 9.2" • Width: 1.5"
• Height: 1.97" • M-LOK

ULIGHT 9ML



HYPER-LIGHT MAGNESIUM 10.75"

Compatibility: AR15 • Length: 10.75" • Width:
1.675" • Height: 2.15" • Key-Mod

HYPLIGHT 10.75KM308



HYPER-LIGHT MAGNESIUM 10.75"

Compatibility: AR15 • Length: 10.75" • Width:
1.7" • Height: 2.15" • M-LOK

HYPLIGHT 10.75ML308



HYPER-LIGHT MAGNESIUM 13.5"

Compatibility: AR15 • Length: 13.5" • Width: 1.7"
• Height: 2.15" • Key-Mod

HYPLIGHT 13.5KM308



HYPER-LIGHT MAGNESIUM 13.5"

Compatibility: AR15 • Length: 13.5" • Width: 1.5"
• Height: 1.97" • M-LOK

HYPLIGHT 13.5ML



HYPER-LIGHT MAGNESIUM 13.5"

Compatibility: AR15 • Length: 13.5" • Width: 1.7"
• Height: 1.97" • M-LOK

HYPLIGHT 13.5ML308



DARKLITE MAGNESIUM M-LOK 11"

M-LOK design for ar15 platform • Length: 11.1 in
• Width: 1.5 in • Height: 1.97 in

DLITE 11ML



ULTRA-LIGHT LITH/ALU 10.75"

Compatibility: AR10, DPMS 308 • Fit 308 DPMS/
SR25 large/high platform • M-LOK

ULIGHT 10.75ML308



ULTRA-LIGHT LITH/ALU 11"

Compatibility: AR15 • Length: 11.1" • Width: 1.5"
• Height: 1.97" • M-LOK

ULIGHT 11ML

BUFFER & BUFFER TUBES



7075 CARBINE

11 position carbine lower extension buffer tube for your AR 15 • Weigh: 3.7 oz

DHCBT



7075 A5 13

13 positions carbine lower extension buffer tube for your AR 15 • Weigh: 3.7 oz

DHCBT2



CASTLE NUT

AR15 castle nut for collapsable stocks • Machined out of 4140 alloy • Black melonite finish

DHCN

RECEIVERS



2055 ENLIGHTENED MATCHED RECEIVER SET

Upper weigh: 5.8 oz • Lower weighs 6.4 oz • Lower ships with quick detach end plate

ENLI ALU-SET



MATCHED STRIPPED RECEIVER SET

MIL-STD 1913 rail for mounting optics accessories • M4 extended feed ramps • Type III hard-coat anodized • Weigh: 6.8 oz

VSEVEN-GISET



GI LOWER RECEIVER

V Seven Weapon Systems • Forged AR-15 lower receiver, constructed from 7075 T6 • Type III hard-coat anodized • Weigh: 8 oz

VSEVEN-GILR

MUZZLE DEVICES



MUZZLE DEVICE FOR 5.56

DarkHour exclusive muzzle device for the AR platform • Available in 1/2x28 for 5.56 & 5/8x24 for 7.62/6.8

DH SSMD556



MUZZLE DEVICE FOR 7.62

DarkHour exclusive muzzle device for the AR platform • Available in 1/2x28 for 5.56 & 5/8x24 for 7.62/6.8

DH SSMD762



3 GUN MUZZLE BRAKE FOR 5.56

Constructed from 303 stainless steel • 1/2x28 for 5.56 • 3 Chamber design

DH3G556



PRECISION BIPODS & MOUNTS



SPIKE FOOT

Warne Skyline Spike feet are an economical and effective way to upgrade your Warne Precision Bipod.

7950M



CLAW FOOT

Warne Skyline claw feet give you the additional floatation needed for stable shooting on loose or loamy surfaces where ordinary feet would sink in.

7951M



PRECISION MOUNT - LEVEL

Precision mount level attaches exclusively to the top of the skyline precision mount, in left or right configurations, to keep the scope reticle consistently level.

7852M

SKYLINE PRECISION MOUNT

The Warne Skyline Precision Mount has been engineered from the ground up with the precision rifle shooter/competitor in mind. Machined from 7075 T6 aluminum billet, featuring 2 integral recoil lugs along with 4 mounting cross bolts and 10 unique accessory mounting locations, the precision mount easily handles the rigors of competition or hard use environments.

7814M



FEATURES

The STANAG rail interface allows for more precise mount alignment, and return to zero capability than a traditional Mil Spec 1913 Picatinny interface while still being compatible with all picatinny rails. The Warne Skyline Precision Mount features a wide assortment of accessories that mount directly to 10 different interfaces on the scope rings.

- Available in 30 mm, 34 mm and 35 mm, Designed and made in USA
- Guaranteed return to zero

PRECISION SCOPE BASE

Warne rails offer shooters the advantage of a consistent mounting platform across multiple firearms, enhanced ability to adjust proper eye relief and superior alignment of ring mounts. With self-centering hardware and aerospace grade materials, our rails provide a lightweight and robust platform for your rifle.

7673M



FEATURES

- Mil-Spec hardcoat anodized finish for abrasion and corrosion resistance.
- Bases feature black zinc coated hardware for "Element Proof" protection.
- Self centering tapered T-15 Torx screws.
- Fits Picatinny & Weaver style mounts and are NATO-STANAG compatible.

PRECISION BIPOD

The Warne Skyline precision bipod is the most functional, ergonomic and strongest bipod on the market today. Designed to attach to your picatinny rail, the Skyline bipod allows the shooter to make quick, one-handed height adjustments, as well as smooth cant and panning ability for use on uneven terrain or less than ideal positions.

7901M



FEATURES

- Quickly attaches to any Picatinny type rail (ARCA fitment option available)
- 5 positions leg rotation: 0°, 45°, 90°, 45°, 0°
- 22° total cant/44° total pan
- One handed adjustability
- Leg extension min height: 6.9" max height: 9.1"

Wilson **C** *Combat*

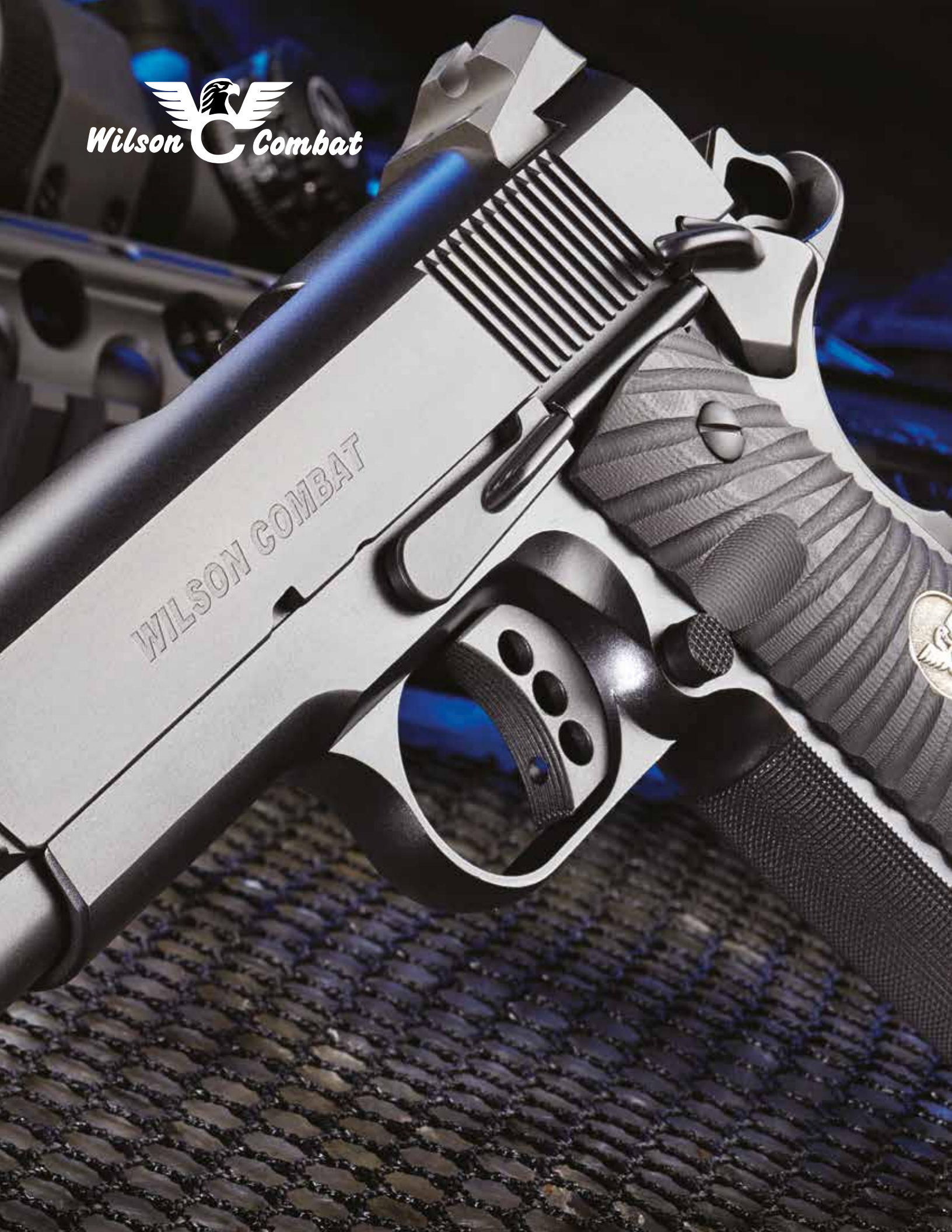

WILSON COMBAT



THE CARRY
COMP PROFESSIONAL
CC-PR-38

| CALIBER | BARREL LENGTH | OVERALL LENGTH | SIGHT RADIUS | HEIGHT | WIDTH |
|--------------------------|---------------|----------------|--------------|--------|-------|
| .45 ACP, 9 mm, .38 Super | 4" | 7.6" | 5.7" | 5.4" | 1.3" |



THE CARRY COMP
CC-CP-38

| CALIBER | BARREL LENGTH | OVERALL LENGTH | SIGHT RADIUS | HEIGHT | WIDTH |
|---------|---------------|----------------|--------------|--------|-------|
| .45 ACP | 4.5" | 8.1" | 5.7" | 5" | 1.3" |



EDXC X9
EDCX-CP-9

| CALIBER | BARREL LENGTH | OVERALL LENGTH | SIGHT RADIUS | HEIGHT | WIDTH |
|---------|---------------|----------------|--------------|--------|-------|
| 9 mm | 4" | 7.4" | 5.6" | 5.25" | 1.4" |



.458 HAM'R ULTIMATE HUNTER
UH-458HF

| CALIBER | BARREL LENGTH | OVERALL LENGTH | WEIGHT EMPTY | MAGAZINE CAPACITY |
|------------|---------------|----------------|--------------|-------------------|
| .458 HAM'R | 18" Fluted | 36.5" | 7 lbs | 7 or 9 Rounds |



THE AR9 CARBINE
TR-AR9B

| CALIBER | BARREL LENGTH | OVERALL LENGTH | WEIGHT EMPTY | MAGAZINE CAPACITY |
|---------|--|-----------------|----------------------------|-------------------------|
| 9 mm | 14.7" (fluted) or 16" (fluted or unfluted) | 31.25 or 32.75" | 6 lbs, 1 oz to 6 lbs, 4 oz | Choose Glock or Beretta |



THE AR9 SBR
TR-AR9G

| CALIBER | BARREL LENGTH | OVERALL LENGTH | WEIGHT EMPTY | MAGAZINE CAPACITY |
|---------|---------------|----------------|---------------------|-------------------------|
| 9 mm | 8" or 11.3" | 25.25 or 28.5" | 5 lbs 6 oz to 6 lbs | Choose Glock or Beretta |



ROCKY FORT HOOD ZIPPER WATERPROOF PUBLIC SERVICE BOOT

Waterproof black leather public service boots



- Guaranteed Rocky Waterproof
- Full-grain leather
- 1,000 Denier CORDURA
- Rubber "SWAT" outsole
- Side Zipper for Easy On and Off
- 8 Inches in height



WWW.ROCKYBOOTS.COM

XS SIGHTS
FASTEST SIGHTS IN ANY LIGHT™



MUZZLE DEVICES



AR-GAT

The GAT allows operators to rapidly breach glass and gain access to high-risk environments while enabling the operator to keep their hand on their weapon. Fit on A1 & A2 flash hider.

GA-0000T-1



CSAT/GAT

The GAT allows operators to rapidly breach glass and gain access to high-risk environments while enabling the operator to keep their hand on their weapon. Fit Ruger flash hider.

GA-0001T-1



SUPPRESSOR GLASS ASSAULT TOOL

The GAT allows operators to rapidly breach glass and gain access to high-risk environments while enabling the operator to keep their hand on their weapon. Fit 1.5" dia. suppressor.

GA-0003T-1

SHOTGUN SIGHTS



TACTICAL GHOST RING SIGHT SET

Rem 870, 1100, 1187 • Banded Tritium Front/Winged Rear

RE-1003-4



SHOTRAIL REM 870 - RAIL & REAR SIGHT BANDED FRONT

Shotrail Rem 870 • whit Banded Standard Dot Tritium Front

RE-4001R-4



SHOTRAIL REM 870 - RAIL & REAR SIGHT

Shotrail Rem 870 • Dovetail Dot Front Sight

RE-4002R-4

RIFLE SIGHTS



XTI DXT BIG DOT

XS Sights XTIs (Xpress Threat Interdiction Sight) for the AR-15/M16 are a secondary sighting solution that provide pistol sights on the side of your carbine that are designed for quick acquisition in CQB situations.

AR-0007-5



FLIP-UP SIGHTS/CSAT & TRITIUM STRIPE

Samson aluminum and steel bases with CSAT A2 aperture and Tritium stripe and white outline front post.

AR-3001-7

HANDGUN SIGHTS



GL-0001S

Glock available: 17, 19, 22-24, 26, 27, 31-36, 38 • Available in Standard Dot, Big Dot, Big Dot Tritium, Standard Dot Tritium, Big Dot Tritium and Std. Dot Tritium.



GL-0002S

Glock available: 20, 21, 29, 30, 30S, 37,41 • Available in Standard Dot, Big Dot, Big Dot Tritium, Standard Dot Tritium, Big Dot Tritium and Std. Dot Tritium.

GL-0002S-1



GL-0003S

DTX Dot • Glock available: 42 & 43 • Available in DX Standard Dot, DXT Big Dot, DXT Standard Dot, Big Dot Tritium, Standard Dot Tritium and Big Dot Tritium.

GL-0003S-1



GL-0004S

Glock Suppressor Heigh available: 17, 19, 22-24, 26, 27, 31-36, 38 • Available in Standard Dot, Big Dot, Standard Dot Tritium, Big Dot Tritium, 24/7 Standard Dot Tritium and 24/7 Big Dot Tritium.

GL-0004S-1



GL-0005S

Glock Suppressor Heigh available: 20, 21, 29, 30, 30S, 37, 41 • Available in Standard Dot, Big Dot, Standard Dot Tritium, Big Dot Tritium, 24/7 Standard Dot Tritium and 24/7 Big Dot Tritium.

GL-0005S-1



GL-0009S

DXT2 Big Dot Orange • Glock available: 17, 19, 22-24, 26, 27, 31-36, 38 • Available in Orange and yellow.

GL-0009S-1



GL-0010S

DXT2 Big Dot Orange • Glock available: 20, 21, 29, 30, 30S, 37, 41 • Available in Orange and yellow

GL-0010S-5N



GL-0011S

DXT2 Big Dot Orange • Glock available: 42 & 43 • Available in Orange and yellow.

GL-0011S-5N



GL-F006P-5 / GL-F007P-5 / GL-F008P-5

F8 Night Sight • Glock available: 17, 19, 20, 21, 22-24, 26, 27, 29, 30, 30S, 31-36, 38, 41, 42 & 43

GL-F006P-5



SI-0002S-5

Sig P225 P226 P228 P229 P320 Springfield XD, XDm & HDs - 24/7 Big Dot Tritium Expr Set.

SI-0002S-5



SI-0013S

DXT2 Big Dot Orange • Glock available: Sig P320, P225, P226, P229, Springfield XD, XDm & XDs • Available in Orange and yellow

SI-0013S-5N



SW-0019S

S&W M&P and Compact • Glock available: 9, 40, 45 SD9 VE SD40 • White Stripe Rear • Available in Big Dot Tritium Front, Standard Front and Standard Dot Tritium Front

SW-0019S-1



A-F 5.5 Black

Boker's Applegate-Fairbairn Black, remain popular, not only for military operations but also because of the added charisma of such a dagger and the additional corrosion protection, which the coating ensures. Therefore Boker felt that it was their duty to include the A-F 5.5, revised by Bill Harsey, in such a lineup. The handles are made of black linen Micarta and the 440C stainless steel blade is given a black PVD coating for an incredibly unique tactical look. Includes a high-quality black nylon sheath.



| | |
|-------------------------|-------------|
| Type: | Fixed Blade |
| Designer: | Bill Harsey |
| Total Length: | 10,6 |
| Blade length: | 5.5 in |
| Blade thickness: | 0.20 in |
| Weight: | 8.5 oz |
| Blade Material: | 440C |
| Handle Material: | Micarta |
| Lock: | Fixed |
| Sheath Material: | Nylon |



BÖKER
MANUFATUR SOLINGEN





ORIGINAL FACTORY REPLACEMENT PARTS

Gravel Defense Division is your supplier for original factory parts and products for maintenance, repairs and upgrades of your guns. Our inventory consists of a large variety of new parts and accessories.

Whether it is Bushmaster Firearms, DPMS, EOTech or Remington, we can provide you with the parts you require.

